

SQUARE STEEL POLE

DESCRIPTION:

The Square Steel Pole is constructed from durable 11-gauge high-strength steel. This pole includes side drill holes for arm mounted lights or tenon mounts. The steel pole with height ranging from 10-30 feet is perfect for various applications such as retail, hospitals, schools, parks, and more.

FEATURES:

- Textured architectural bronze powder-coat finish, baked for maximum durability and adhesion.
- Anchor bolts not included, sized based on the selected pole size.
- Cast iron reinforced hand hole with ground screw cover.
- Two-piece formed steel base cover for easy assembly and fit.
- Standard pole lengths listed in the order matrix; custom lengths available upon request.
- Hot-dip galvanized surface treatment.

APPLICATIONS:

- Retail centers
- Industrial parks
- Schools and universities
- Public transit
- Airports
- Office buildings
- Medical facilities



DIMENSIONS:

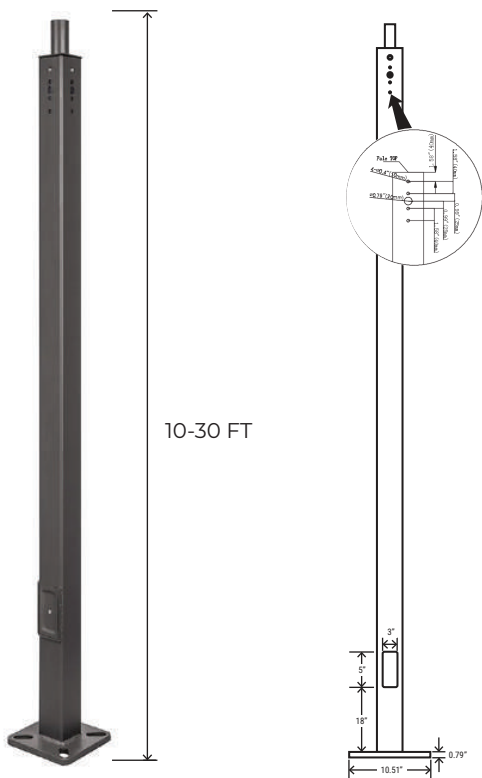

4" Flange

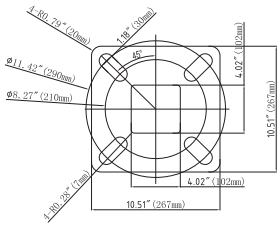

5" Flange

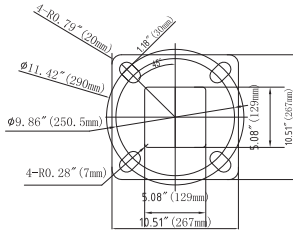

Flange Base Cover

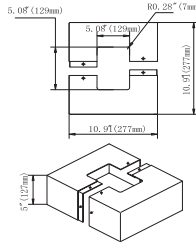

Anchor Bolt Positioning Plate

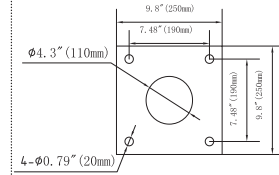

Anchor Bolt

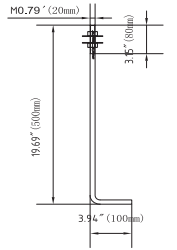

DIMENSIONS DATA:

CATALOG	HEIGHT	GAUGE	SIZE	BASE	BOLT CIRCLE	BOLT SIZE	WEIGHT (LBS)	EPA 70	EPA 80	EPA 90	EPA 100	EPA 110	EPA 120
NUR-WSD-10FT4-11G-D-T	10ft	11	4"x4"	11"	8.27"-11.42"	M0.79"x19.69"x3.94"	101	25.2	23.5	20.3	19.4	17.3	15.6
NUR-WSD-15FT4-11G-D-T	15ft						134	15.2	13.5	11.1	9.5	7.9	6.8
NUR-WSD-20FT4-11G-D-T	20ft						169	10.2	9.3	7.5	6.2	4.2	3.6
NUR-WSD-25FT4-11G-D-T	25ft						190	8.9	6.9	5.7	4.1	3.6	2.2
NUR-WSD-30FT4-11G-D-T	30ft		5"x5"	9.86"-11.42"	M0.79"x19.69"x3.94" / M0.95"x36"x4"	286	9.6	7.4	6.1	5.8	4.6	3.8	

MOUNTING OPTIONS:

Side Mount: Standard length poles come pre-drilled on all four sides. A Tenon standard is included and can be placed on top. Additionally, hole plugs are provided for any unused pre-drilled spots.

Note: If you intend to use an Arm or Slip-Fitter Mount, additional parts may be required for proper installation. For instance, a Slip-Fitter mount often necessitates a bullhorn attachment.

Top Mount: Installing an ARM simply remove the Tenon standard and install a rain cover on top.



ORDERING GUIDE

Example: NUR-WSD-10FT4-11G-D-T

Fixture	Length	Gauge	Finish	Mounting
NUR-WSD		11G	D	T
	10FT4 10FT 15FT4 15FT 20FT4 20FT 25FT4 25FT 30FT4 30FT			

GROUND MOUNTING KIT (SOLD SEPRATLEY) :

Base Cover for 4" Wide Square Light Pole, 20" x 4" Anchor Bolts (x4), Screw Positioning Plate

Our light pole installation kit uses a Screw Positioning Plate for the foundation base of a steel light pole. It helps to position the foundation anchor bolts and fix them underground so there is no deviation.

SKU: NUR-WSD-POLE-INSTALLATION KIT

DIMENSIONS:

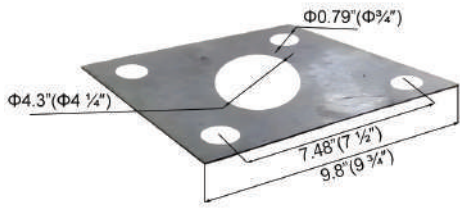

Screw Positioning Plate

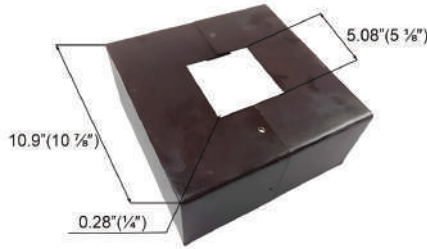

Base Shield

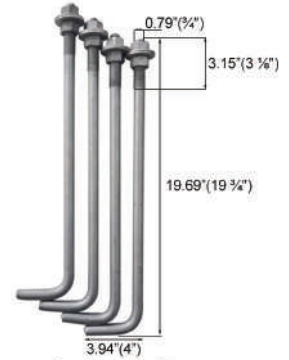

Anchor Bolts