

LEDCITY
SIGNS & LIGHTS



**COMMERCIAL
CATALOG 2024**

L.E.D. CITY[®]

SIGNS & LIGHTS



At LED City we are passionate about lighting! We love to collaborate with our customers to find the best lighting solutions for your projects.

CONTENTS

03

DEALER PROGRAM

04

OUR SERVICES

05

RESIDENTIAL DOWNLIGHTING

06 5 in 1 CCT Tunable Downlight

07 Adjustable CCT LED Disklight

08

COMMERCIAL RETROFIT

09 High Output Double PCB V Shaped Tube

10 Double Sided Tube

11 T8 Smart LED Tube Light

12 T8 Standard LED Tube Light (Ballast Bypass)

13 LED G24 PL Lamp

14

COMMERCIAL INTERIOR

15 LED Linear Strip

16 Architectural Linear Strip Light

17 LED Backlit Panel Light

18 Commercial Downlight

19 Commercial Downlight 6"

20 Recessed Slim Linear Fixture

21 Surface Slim Linear Fixture

22 Up/Down Linear LED Light

23 Vertical Linear LED Light

24 Track Head Universal Holder

25 Blue Electrical Box

26-27 Integrated Junction Box Downlight

28-29 Flat T-Grid Linear

30-31 Zeta Slim Linear Pendant Lighting

32

HIGH BAY

33 LED Linear High Bay 1

34 LED Linear High Bay 2

35 LED UFO High Bay Watt. and CCT Adjustable

36 Genesis High Bay

37

COVERED PARKING

Round Canopy Light 38

Square Canopy Light 39

40

WALL MOUNTED

LED Wall Mount 41

Illustration 42-43

Slim Wall Pack 44

LED Wall Pack 45

Wall Pack (WP04) 46

LED Full Cutoff Wall Pack 47

Dusk To Dawn Light 48

49

ARCHITECTURAL

Mini Flood Light 50-51

Bullet Light 52

53

PARKING LOT / POLES

Illustration 54-55

Lexin 56

LED Flood Light FL05 57-58

LED Flood Light FL08 59

Flood Light FL11 60

LED Swan Post Light 61

LED Post Top Light 62

FL10Pole 63

Pole Accessories 64-65

66

EXIT/EMERGENCY

Exit Light 67

Exit Sign With 68

Emergency Light Head

LED Emergency Light Head 69

CONTRACTOR'S PROGRAM

DEMO CHECKOUT

Borrow samples of the latest in-demand products to demonstrate for your client.

QUARTERLY CREDIT BACK

Purchase more than \$5000 of goods on carry quarter & earn 4% as credit towards your next quarter's purchase.

BULK/DISCOUNTED PRICES

Special prices exclusive for dealers.

FREE DELIVERY

Free local delivery within 30 miles of LED CITY for any order of \$1000 or more.

FREE TRAINING

Product and installation training on any LED CITY'S products for dealers and their associates.

Signing up to our Dealer Program is FREE!
Go to this URL:
ledcityusa.com/dealerprogram



LIGHTING DESIGN SERVICES BY

LED CITY[®]

SIGNS & LIGHTS



WHY LIGHTING FROM LED CITY
COST LESS?

HOW MOST NORMALLY PURCHASE LIGHTING:

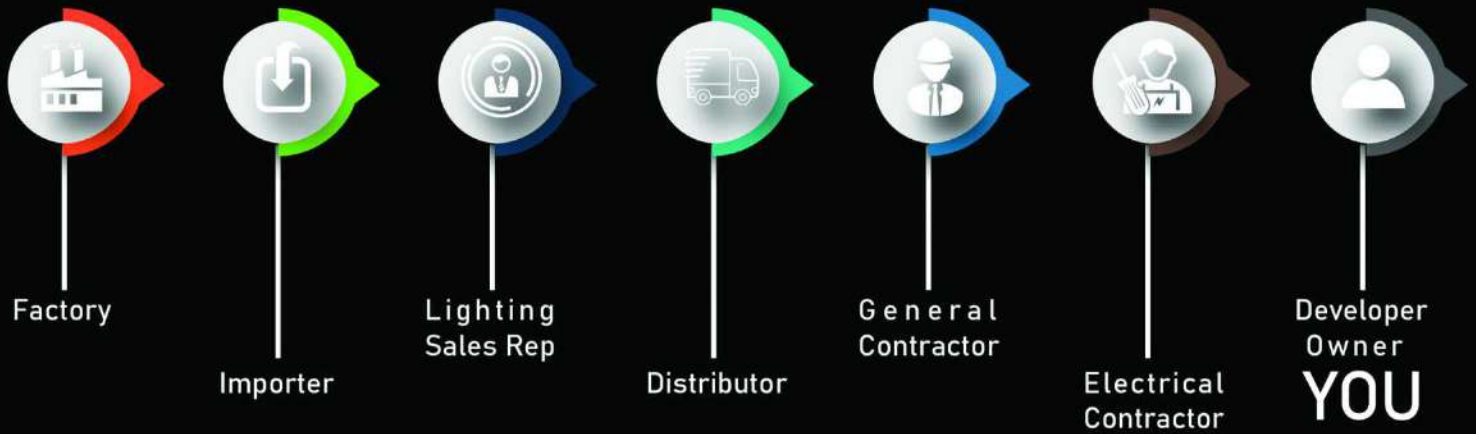

LED CITY SELLS DIRECT FROM THE FACTORY

NO MIDDLE-MEN, **LESS** MARKUP & **LESS** COST



RESIDENTIAL DOWNLIGHT

A recessed light or downlight is a light fixture that is installed into a hollow opening in a ceiling. The housing is the fixture itself that is installed inside the ceiling and contains the lamp holder.



CONTENT:

- 5 in 1 CCT Tunable Downlight (4 inch and 5/6 inch)
- Adjustable CCT LED Disklight

PAGE NO#

06
07

5/6 inch



4 inch Downlight



CCT Disklight



5 IN 1 CCT TUNABLE DOWNLIGHT

DESCRIPTION :

The new CCT downlight comes with a small selector switch that allows the user to select the color temperature from 2700K/3000K/3500K/4000K/5000K. It is highly efficient and compatible with most dimmers. Suitable for residential and commercial applications.

FEATURES :

- Aluminum housing with white finish
- Can be recessed mounted
- 80% energy savings as compared to incandescent/halogen bulbs
- E26 base



APPLICATIONS :

- Hotels
- Corridors
- Home decoration
- Shopping malls
- Exhibition rooms

TRIM ACCESSORY :



- Trims sold separately



4 INCH ROUND DOWNLIGHT



5/6 INCH ROUND DOWNLIGHT

MODEL	COLOR TEMPERATURE	POWER	LUMEN OUTPUT	SIZE	INPUT VOLTAGE RANGE	AVAILABILITY
DWN-NUR-CCT-R-4-10W	Switchable Between 2700K 3000K	10W	600LM, 650LM, 700LM, 750LM, 800LM	4 INCH	120VAC	IN STOCK
DWN-NUR-CCT-R-5/6-15W	3500K 4000K 5000K	15W	1000LM, 1150LM, 1200LM, 1250LM, 1300LM	5 (extendable upto 6 INCH)		

4 inch



scan to buy



6 inch



scan to buy

ADJUSTABLE CCT LED DISKLIGHT

DESCRIPTION :

The new CCT disklight has a unique appearance and high efficiency. You can adjust the color temperature from warm white to natural white to cool white using a color temperature selector switch. It can easily replace surface mount and recessed downlights and is ideal to be used in residential and commercial applications.

FEATURES :

- Triac dimmable
- Color temperature can be adjusted between five colors
2700K/3000K/3500K/4000K/5000K
- Fits directly to standard 4" to 5" round, square or octagonal electrical boxes
- With recessed can accessory (sold separately), it can also fit onto standard 4", 5", or 6" recessed cans



APPLICATIONS :

- Hotels
- Corridors
- Home decoration
- Shopping malls
- Exhibition rooms

unit: inch

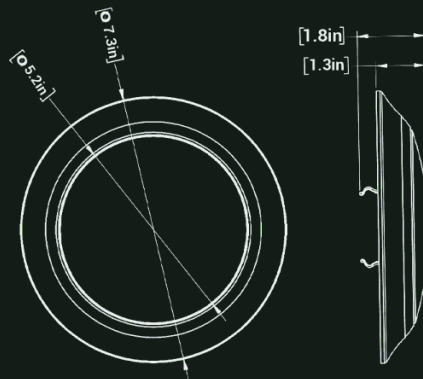

MODEL	COLOR TEMPERATURE	POWER	LUMEN OUTPUT	INPUT VOLTAGE RANGE	AVAILABILITY
DK-SC-15W-5CCT-WHT	2700K	15W	975 LM	120VAC	IN STOCK
	3000K		1080 LM		
	3500K		1275 LM		
	4000K		1290 LM		
	5000K		1100 LM		



LM80



scan to buy

COMMERCIAL RETROFIT

A simple definition of a retrofit, or a relighting, is the renovation of your old lighting fixture and/or bulbs that improves the lighting



CONTENT:

PAGE NO#

▪ High Output Double PCB V Shaped Tube	09
▪ Double Sided Tube	10
▪ T8 Smart LED Tube	11
▪ T8 Standard LED Tube Light (Ballast Bypass)	12
▪ LED G24 / PL Lamp	13

Double Sided Tube



High Output Double PCB V Shaped Tube



T8 Smart LED Tube Light



HIGH OUTPUT DOUBLE PCB V SHAPE TUBE

DESCRIPTION :

The high lumen output SMD2835 LED is used to provide the brightness levels of 125-130 Lumens per watt. It can be used as a direct replacement for a fixture that does not require ballasts. It has a life expectancy 5 times more than the fluorescent tubes, reducing the cost of repairs, disposal fee and the need for replacements.

FEATURES :

- Housing is made of high-purity aluminum material and plastic
- Can directly fit into standard fluorescent sockets and high output fluorescent sockets
- Can be powered from RDC end cap or Bi-Pin end cap
- Ballast bypass only

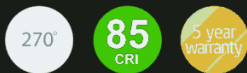

APPLICATIONS :

- Replacement for conventional panel lights
- Hotels, offices, meeting rooms
- Factories
- Supermarkets, parking lots
- Airports, Railroad stations



ACCESSORIES



CLIPS INCLUDED

MODEL	COLOR TEMPERATURE	POWER	LUMEN OUTPUT	EFFICACY	REPLACES	INPUT VOLTAGE RANGE	AVAILABILITY
T8-V-4FT-30W-6000K-CLR	6000K	30W	3,750 LM	125 LM/W	60W Fluorescent Tube	120-277VAC	IN STOCK
T8-V-5FT-36W-6000K-CLR		36W	4,500 LM		72W Fluorescent Tube		
T8-V-6FT-40W-6000K-CLR		40W	5,000 LM		80W Fluorescent Tube		
T8-V-8FT-60W-6000K-CLR		60W	7,500 LM		120W Fluorescent Tube		



scan to buy

DOUBLE SIDED TUBE

DESCRIPTION:

Highly efficient double sided tube uses SMD2835 technology for maximum lumen output. This energy saving tube, with its high lumen output is suitable for use in commercial applications.

FEATURES :

- Can be powered from RDC end cap or Bi-Pin end cap.
- Direct fit florescent fixtures without the need of a ballast.
- High-Bright chip smd to save more energy and increase life time.
- 98% Transmittance inner pc for max output.



APPLICATIONS :

- Box Sign
- Signage

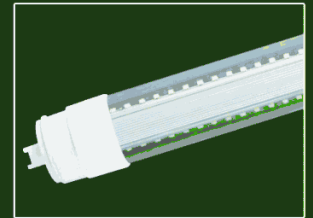
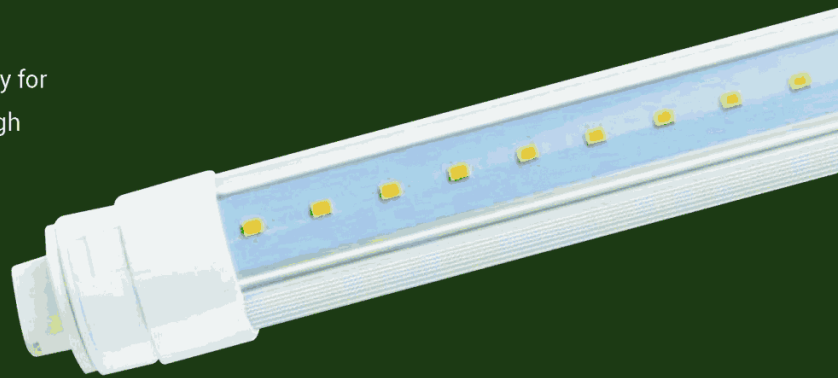

ACCESSORIES



CLIPS INCLUDED

MODEL	COLOR TEMPERATURE	POWER	LUMEN OUTPUT	EFFICACY	SIZE	INPUT VOLTAGE RANGE	AVAILABILITY
T8-D-7FT-36W-6000K-CLR	6000K	36W	4,680 LM	130 LM/W	7FT.	100-277VAC	IN STOCK
T8-D-8FT-40W-6000K-CLR		40W	5,200 LM		8FT.		



scan to buy

T8 SMART LED TUBE

DESCRIPTION :

Our new T8 tube is made of aluminum and shatterproof plastic for increased durability, making it the best retrofit choice for use in schools, offices, retail stores and supermarket. LED smart tube can be used as both, ballast ready tube or a ballast bypass tube. When bypassing ballast, our smart tube can be wired for single ended power or double ended power.

FEATURES :

- Compatible with most electronic and electro-magnetic ballasts
- Can directly replace traditional fluorescent lamps
- Direct replacement for most T8, T10 or T12 bulbs.

5 year warranty

APPLICATIONS :

- Schools
- Offices
- Supermarkets and retail stores
- Factories

DIMENSION :

unit: inch

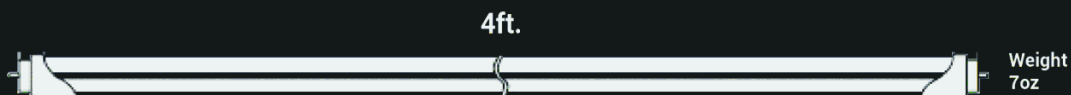

MODEL	COLOR TEMPERATURE	POWER	LUMEN OUTPUT	EFFICACY	LENGTH	INPUT VOLTAGE RANGE	AVAILABILITY
T8-SMT-TP-4FT-18W-3000K-CLR-MO	3000K	18W	2,340 LM	130 LM/W	4FT.	120-277VAC	IN STOCK
T8-SMT-TP-4FT-18W-3000K-FRS-MO			2160 LM	120 LM/W			
T8-SMT-TP-4FT-18W-4000K-CLR-MO	4000K		2430 LM	135 LM/W			
T8-SMT-TP-4FT-18W-4000K-FRS-MO			2250 LM	125 LM/W			
T8-SMT-TP-4FT-18W-5000K-CLR-MO	5000K		2430 LM	135 LM/W			
T8-SMT-TP-4FT-18W-5000K-FRS-MO			2250 LM	125 LM/W			



scan to buy

T8 STANDARD LED TUBE LIGHT (BALLAST BYPASS)

DESCRIPTION :

Tube lighting is the most popular lighting source for general lighting in commercial applications. Whether it is fluorescent T8, T10 or T12 tube, our LED tube can be used to replace it. These tube do not require ballasts and are ideal for low cost upgrade. When bypassing ballast, our smart tube can be wired for double ended power.

FEATURES :

- High luminous efficiency
- Aluminum heat sink allows for better heat dissipation
- Longer life and low maintenance costs
- 2FT tube lights have bi pin and RDC end cap options
- 8FT tube lights have single pin, bi pin and RDC end cap options



APPLICATIONS :

- Can be used for all general lighting applications in:
- Factories
- Warehouses
- Retail stores
- Hotels
- Office buildings

DIMENSION :

unit: inch

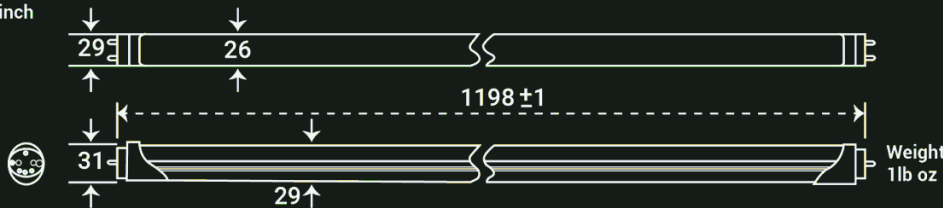

OPTIONS



MODEL	COLOR TEMPERATURE	POWER	END CAPS	LENGTH	INPUT VOLTAGE RANGE	AVAILABILITY
T8-2FT-3000K-CLR-SO	3,000K	9W	Bi Pin	2FT.	120-277VAC	IN STOCK
T8-2FT-3000K-FRS-SO						
T8-2FT-4000K-CLR-SO	4,000K					
T8-2FT-4000K-FRS-SO						
T8-2FT-5000K-CLR-SO	5,000K					
T8-2FT-5000K-FRS-SO						
T8-TP-8FT-5000K-CLR-SO-OS	5,000K	32W	Bi Pin	8FT.		
T8-TP-8FT-5000K-CLR-SO-SNGPIN			Single Pin			
T8-TP-8FT-5000K-FRS-SO-OS			Bi Pin			
T8-TP-8FT-5000K-FRS-SO-SNGPIN			Single Pin			



scan to buy

LED G24/PL Lamp

DESCRIPTION :

LED G24 Retrofit Lamps are both electrical ballast and 120-277V line voltage compatible. G24 LED lamps have G24 base and can be used with adaptors for different applications. PL lamps have an E26 base. These lamps are good for replacement for CFL bulbs and can be used for general lighting, wall sconces and recessed cans.

FEATURES :

- Made of die casting aluminum heat sink
- Operating temperature is -4°F to 105°F
- Available in horizontal and vertical orientations
- G24 Horizontal lamp is rotatable for 180°



APPLICATIONS :

- Recessed cans
- Wall sconces
- General lighting

ACCESSORIES:



G24 ADAPTOR-L



E-26 MALE TO G24 FEMALE CONVERTER



G24 ADAPTOR-S



G24-25W LED LAMP



E26-30W PL LAMP



PL-12W VERTICAL ORIENTED LAMP

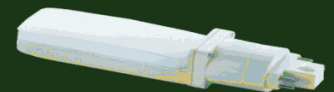

PL-12W HORIZONTAL ORIENTED LAMP

MODEL	COLOR TEMPERATURE	POWER	LUMEN OUTPUT	EFFICACY	BASE	INPUT VOLTAGE RANGE	AVAILABILITY
G24-12W-3000K-H	3000K	12W	900 LM	75 LM/W	G24	120-277VAC	IN STOCK
G24-12W-3000K-V							
G24-12W-4000K-H	4000K	1,100 LM	92 LM/W				
G24-12W-4000K-V							
G24-25W-3000K-V	3000K	25W	2,500 LM	100 LM/W			
G24-25W-4000K-V							
G24-25W-5000K-V							
PL-E26-30W-4000K-V	4000K	30W	3,000 LM	100 LM/W			
PL-E26-30W-5000K-V	5000K						



scan to buy

COMMERCIAL INTERIOR

Commercial lighting is used to describe lighting that is employed in commercial environments in order to illuminate the space. Commercial LED lighting has a wide range of indoor/outdoor applications due to its energy-saving capabilities and the potential to significantly reduce utility cost.



CONTENT:

PAGE NO#

▪ LED Linear Strip	15
▪ Architectural Linear Strip Light	16
▪ LED Backlit Panel Light	17
▪ Commercial Downlight	18
▪ Commercial Downlight 6"	19
▪ Recessed Slim Linear Fixture	20
▪ Surface Slim Linear Fixture	21
▪ Up/Down Linear LED Light	22
▪ Vertical LED Linear Light	23
▪ Track Lighting	24
▪ Blue Electrical Box	25
▪ Integrated Junction Box Downlight	26-27
▪ Flat T-Grid Linear	28-29
▪ Zeta Slim Linear Pendant Lighting	30-31



Surface Slim Linear



Track Lighting



Vertical Linear LED Light

LED LINEAR STRIP

DESCRIPTION :

The high output strip light might be the most versatile light on the market. It can be used any place a fluorescent fixture can with easy linkable capability. Very popular among residential/commercial garages, commercial retail space and offices.

FEATURES :

- Die formed painted steel
- Color temperature: -4°F~+104°F (-20°C~40°C)
- Optics: Frosted diffuse PC lens
- IP Rating: Damp location IP44
- Sensor: Motion sensor (optional) and Emergency backup battery (optional)
- Dimmable: No
- Mounting: Surface mount and suspended mount
- Application: Indoor



APPLICATIONS :

- Ideal for new construction and renovations.
- Offices
- Schools
- Hospitals
- Corridors Lights

DIMENSION :

unit: inch

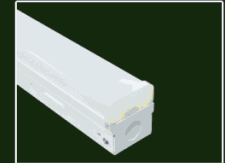
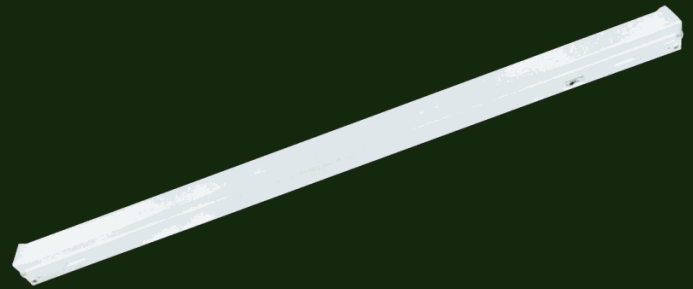

ACCESSORIES



SENSOR-SCREW ON
(SPECIAL ORDER)



EMERGENCY BATTERY BACKUP
NUR-WP-BATTERY



MOUNTING PLATE

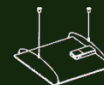

SUSPENSION KIT

MODEL	COLOR TEMPERATURE	POWER	SIZE	LUMEN OUTPUT	LUMEN PER WATT	INPUT VOLTAGE RANGE	AVAILABILITY
NUR-ST-4FT-40W-CCT	CCT ADJUSTABLE	40W	4FT.	4600 LM	115 LM/W	120-277VAC	IN STOCK
NUR-ST-4FT-40W-CW	(3000K, 4000K, 5000K)						



scan to buy

ARCHITECTURAL LINEAR STRIP LIGHT

DESCRIPTION :

Architectural Linear Strip offers a sleek design to elevate your space with customizable lighting, boasting a slim, clean appearance. ALS series can run seamlessly and easily at any length in a straight line or any modeling design by DIY connectors. 5CCT selectable color temperatures. Available in 2ft, 3ft, 4ft and 8ft length and two variants white/black.

FEATURES :

- Easy and quick installation reduces labor cost and optimizes ROI.
- 1200W Max linkable wattage
- CCT Selectable (include the 5CCT options)
- Adjustable Light Distribution
 - i) UP: 0% & DOWN: 100%
 - ii) UP: 70% & DOWN: 30%
 - iii) UP: 50% & DOWN: 50%
 - iv) UP: 30% & DOWN: 70%
 - v) UP: 100% & DOWN: 0%
- Mounting Options: Suspension/Recessed/Surface/Wall Mount



APPLICATIONS :

- Offices
- Conference rooms
- Hallways

ACCESSORIES (OPTIONAL):

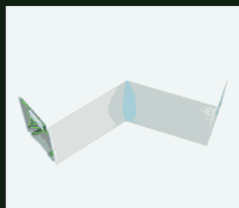
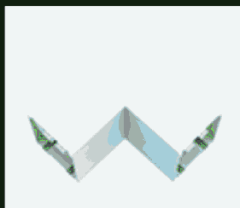

- 90° Connector
- 120° Connector
- T Connector
- X Connector
- Wall Mount Bracket
- SKU: SUN-CONN-ST-5CCT-90
- SKU: SUN-CONN-ST-5CCT-120
- SKU: SUN-CONN-ST-5CCT-T
- SKU: SUN-CONN-ST-5CCT-X
- SKU: SUN-MNT-WALL-BRCKT

STRIP LIGHT	LENGTH	WATTS	COLOR TEMPERATURE	FINISH	AVAILABILITY
NUR-ST	2ft 2 feet 3ft 3 feet 4ft 4 feet 8ft 8 feet	30W 35W 50W 100W	5CCT (Selectable)	WHT White BLK Black	IN STOCK



scan to buy

LED BACKLIT PANEL LIGHT

DESCRIPTION :

The Back Lit LED Panel is designed to be used for general lighting from a drop ceiling (acoustic tile ceiling grid). It an energy-efficient and reliable lighting solution that transmits even light without flicker thru an acrylic lens with no dark spots.

FEATURES :

- Adjustable CCT (35K/40K/50K)
- Adjustable Power 2x2 (25W/30W/35W) 2x4 (30W/40W/50W)
- LGP-free design prevents yellowing
- Lumen output: 125 lumens per watt
- Compatible with AC120-277V and 0-10V dimming
- Operating temperature is 14°F to 104°F (-10°C to 40°C)
- Dimmable via 0-10V dimmer



APPLICATIONS :

- Offices
- Hotels
- Shopping malls
- Hospitals

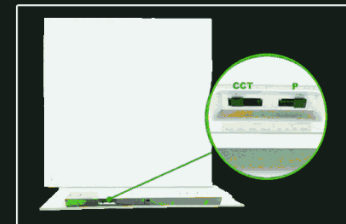
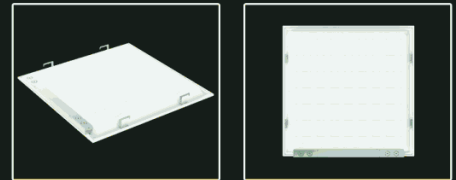

ACCESSORIES

- SURFACE MOUNT FRAME
- SUSPENSION KIT
- RECESSED MOUNT FRAME KIT
- EMERGENCY BATTERY BACKUP
NUR-WP-BATTERY

unit: inch

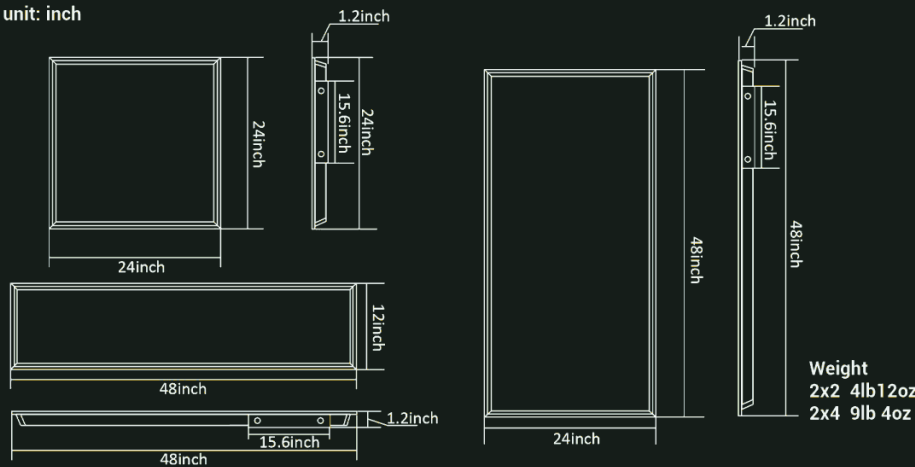

MODEL	POWER	DIMMABLE	EFFICACY	COLOR TEMPERATURE	SIZE
SLS-SJ-2X2-CCT	25-30-35	0-10V Dimming	130 LM/W	3000K	24*24
SLS-SJ-1X4-CCT		Power & Color Temperature		4000K	12*48
SLS-SJ-2X4-CCT	30-40-50	Tunable		5000K	24*48



scan to buy

COMMERCIAL DOWNLIGHT

DESCRIPTION :

It can retrofit for most manufacturers incandescent, CFL or H.I.D. fixtures with apertures of 6.1" min. to 6.7" max diameter. Easy conversion method and recessed installation can be performed from below the ceiling without removing existing fixture.

FEATURES :

- CCT Adjustable option available.
- Input voltage: 100-277V AC
- 1-10 dimmable
- Recessed mounted



APPLICATIONS :

The retrofit downlight for installation in all compatible recessed housings found in:

- Hotels
- Offices
- Majors retail stores
- Education facilities
- Government bulidings
- Hospitals

DIMENSION :

unit: inch

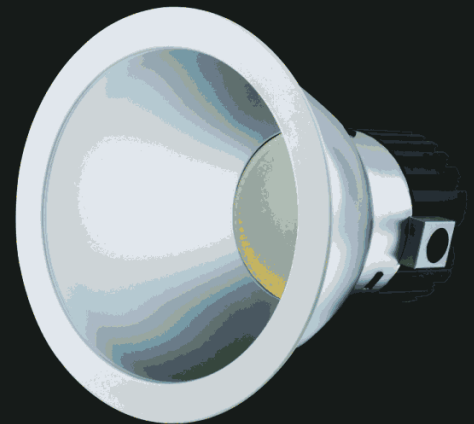
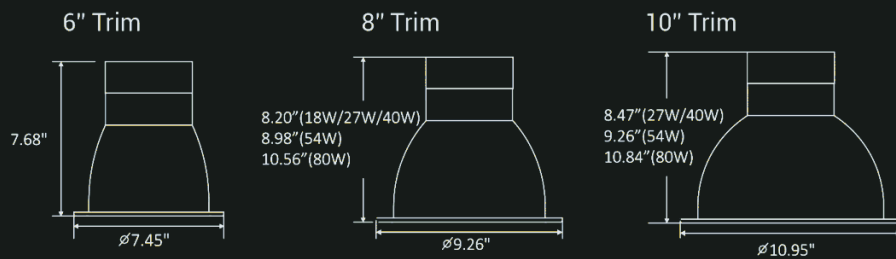

Light Engine with Trim



Light Engine

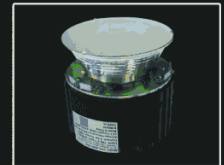

ACCESSORIES



TRIM
NUR-CE-TRIM

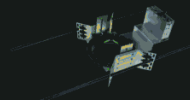

CONSTRUCTIONAL FRAME
NUR-CE-FRAME

MODEL	COLOR TEMPERATURE	POWER	LUMEN OUTPUT	TRIM OPTIONS	INPUT VOLTAGE RANGE	AVAILABILITY
NUR-CES-XXW40-CCT	CCT ADJUSTABLE 3000K, 3500K, 4000K	40W	1,710 LM, 2,565 LM, 3,800 LM	6", 8", 10"	120-277VAC	IN STOCK



scan to buy

COMMERCIAL DOWNLIGHT 6"

DESCRIPTION :

This commercial grade recessed downlight is 15 products in 1. Now available in 3 wattages and 5 CCT tunable. 120-277V@60HZ input voltage, 0-10V dimming.

Wet-location and IC rated. Ideal use is for general lighting.

FEATURES :

- High luminous efficacy, up to 135LM/W
- High quality Aluminium shell with frosted PC diffuser
- Supports 0-10V dimming from 100% to 10%
- 80% more energy savings than halogen lamps.



APPLICATIONS :

- Commercial Properties
- Hospitality
- Healthcare Industry
- Schools
- Campuses
- Shopping Centers
- Industrial Areas
- Hotels

DIMENSIONS:

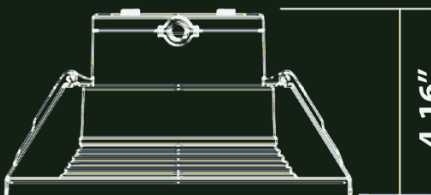

INCLUDED:

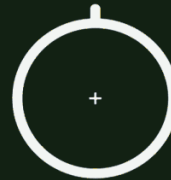

HOLE CUTOUT CARD



scan to buy

RECESSED SLIM LINEAR FIXTURE

DESCRIPTION :

Recessed Slim Linear Fixture is available in 4ft and 8ft lengths. Each fixture comes standard with 3 selectable color temperatures (3000K/ 3500K/ 4000K) providing flexibility to adapt to changing needs. This design pleases designers, contractors and wholesalers alike.

FEATURES :

- Ultra thin profile with external driver
- Provides powerful lines in any applications
- Easy and quick recessed installation
- Works with most ceiling types
- Emergency or sensor function options



APPLICATIONS :

Ideal for new construction and renovations. Perfect for

- Offices
- Schools
- Hospitals
- Corridors Lights

DIMENSION :

unit: inch

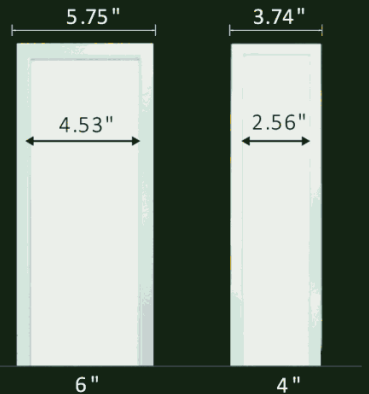
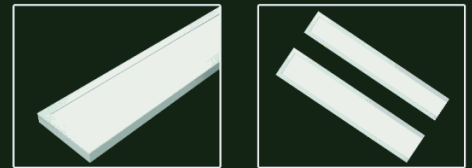
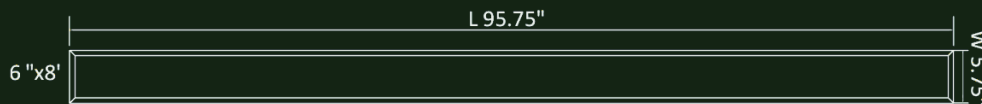
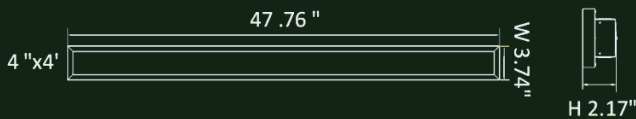

MODEL	COLOR TEMPERATURE	POWER	SIZE	LUMEN OUTPUT	LUMEN PER WATT	INPUT VOLTAGE RANGE	AVAILABILITY
NUR-LR44-CCT-DIM	CCT ADJUSTABLE	40W	4' length, 4" width	3400LM, 3800LM, 3600LM	900 LM/FT	120-277VAC	IN STOCK
NUR-LR86-CCT-DIM	(3000K, 3500K, 4000K)	80W	8' length, 6" width	7600LM, 8400LM, 8000LM	1000 LM/FT		



scan to buy

SURFACE SLIM LINEAR LED

DESCRIPTION :

This LS (Linear Surface) series is a high-performance luminaire, featuring top-end performance paired with a modern aesthetic. The true ingenuity comes from its unique construction, its architectural linear LED lighting is integrated with surface and recessed mounting along with a built-in driver.

FEATURES :

- Ultra thin profile, only 0.94" thickness
- Tested Dimmers: Lutron ® Diva-Dvtv, Leviton ® IP-710-D
- Recessed mounted
- Integrate with surface mounted and recessed with built-in driver
- LED Lifetime: >50,000H L70 minimum



APPLICATIONS :

- Offices
- Schools
- Light Industrial Spaces

DIMENSION:

unit: inch

6" x 2'

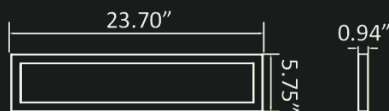

4" x 4'

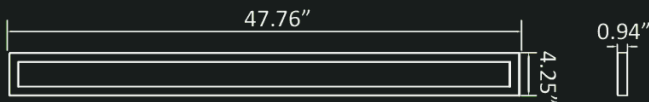

6" x 4'

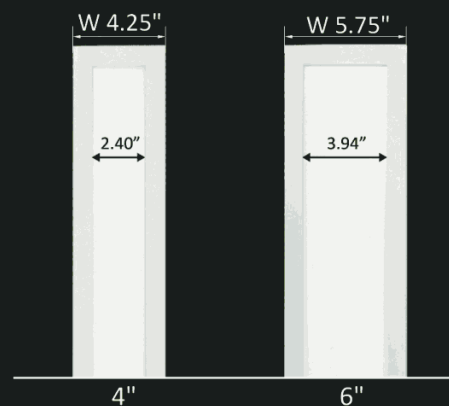
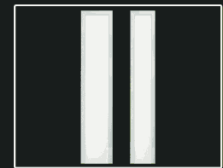
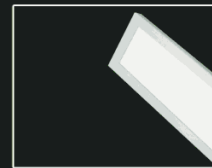
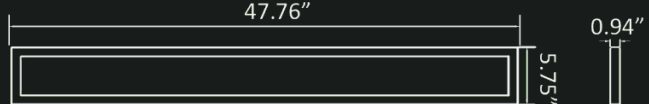

MODEL	COLOR TEMPERATURE	WATTAGE SELECTABLE	SIZE	LUMEN OUTPUT	INPUT VOLTAGE RANGE	AVAILABILITY
NUR-LS26-CCT-DIM	CCT ADJUSTABLE	40W/30W/20W	2' length, 6" width	1,600 LM, 1,800LM, 1,700LM	100-347VAC	IN STOCK
NUR-LS44-CCT-DIM	3000K, 3500K, 4000K	40W/30W/20W	4' length, 4" width	3,000LM, 3,400LM, 3,200LM	100-347VAC	IN STOCK



scan to buy

UP/DOWN LINEAR LED LIGHT

DESCRIPTION :

Up/Down linear LED light is a commercial pendant lighting fixture utilizing an advanced LED optical system to achieve superior performance. The unique design is nearly transparent luminaire when off and excellent uniformity and efficiency when on, reaching 55% downlighting and 45% uplighting distribution, making the illusion of the light floating in mid-air, included UL Recognized constant current driver which support 0-10V dimming, suitable for indoor lighting. It has color temperature changing optional

FEATURES :

- Tested Dimmers: Lutron ® Diva-Dvtv, Leviton ® IP-710-D
- CCT adjustable option by dip switch
- Unified Glare Rating (UGR) <17
- Internal & replaceable driver
- 110-347V AC Input option available
- Seamless continuous runs, up to 36' in 120V and 80' in 277V per power feed (4FT)
- Seamless continuous runs, up to 32' in 120V and 80' in 277V per power feed (8FT)
- LED Lifetime:>50,000H L70 minimum



DIMENSION :

unit:inch

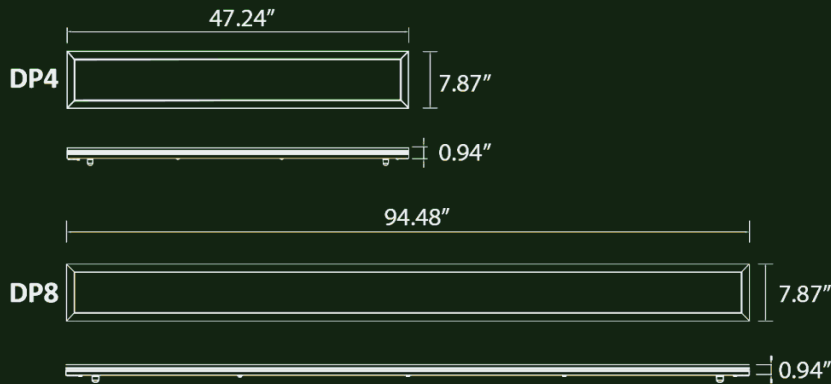

ACCESSORIES



DRY CEILING
2" & 4" ROUND CANOPY



DRY CEILING
2" & 4" SQUARE CANOPY

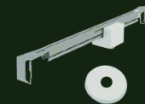

DROP CEILING
T-GRID HANGER
2" & 4" ROUND CANOPY

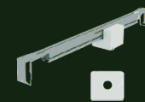

DROP CEILING
T-GRID HANGER
2" & 4" SQUARE CANOPY



SUSPENSION KIT



SHEET ROCK

MODEL	COLOR TEMPERATURE	POWER	SIZE	LUMEN OUTPUT	LUMEN PER WATT	INPUT VOLTAGE RANGE	AVAILABILITY
NUR-DP4-DIM-CCT	CCT Tunable (3000K 3500K, 4000K)	40W	4' length, 8" width	4200 LM	115 LM/FT, 1150LM/FT	110-347VAC	IN STOCK



CCT Adjustable



scan to buy

VERTICAL LINEAR LED LIGHT

DESCRIPTION :

The LV series suspended linear LED light fixture combines brilliant design and intuitive engineering to deliver unprecedented performance. It is a distinct statement in any workspace.

FEATURES :

- Finish: Silver
- Transparent vertical optics, enveloped in a signature sloping silhouette
- T-grid Or Dry ceiling compatible
- CCT adjustable: 3000K,3500K,4000K by dip switch
- Suspended mounting
- Seamless continuous runs, up to 40' per power feed
- Internal driver



DIMENSION :

unit:inch

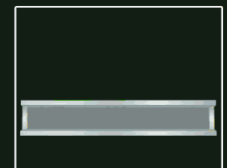
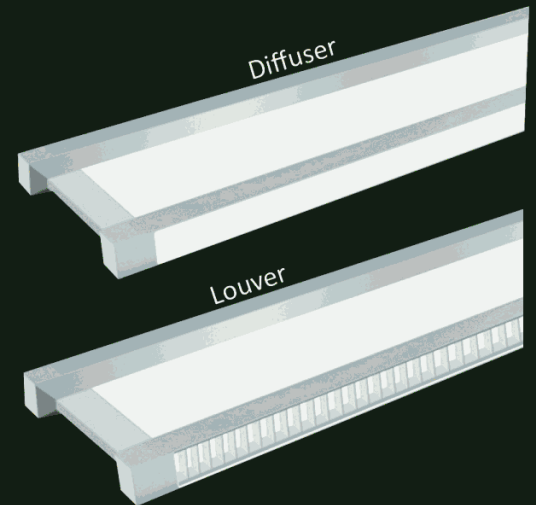
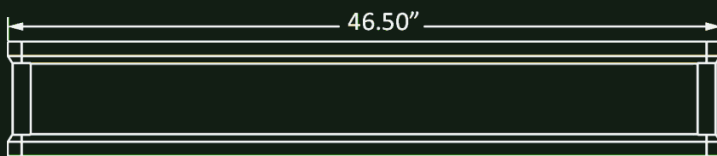

ACCESSORIES



DRY CEILING
2" & 4" ROUND CANOPY



DRY CEILING
2" & 4" SQUARE CANOPY



DROP CEILING
T-GRID HANGER
2" & 4" ROUND CANOPY

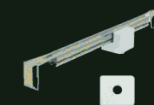

DROP CEILING
T-GRID HANGER
2" & 4" SQUARE CANOPY

MODEL	COLOR TEMPERATURE	POWER	LUMEN OUTPUT	SIZE	EFFICACY	OPTICS	INPUT VOLTAGE RANGE	AVAILABILITY
NUR-LV4-40W-CCT-DIM	CCT ADJUSTABLE 3000K,3500,4000K	40W	4,000 LM	4FT	100 LM/W, 1000 LM/FT	DIFFUSER	120-277VAC	IN STOCK
			3,600 LM		90 LM/W, 900 LM/FT	LOUVER		



scan to buy

TRACK HEAD-UNIVERSAL HOLDER

DESCRIPTION :

Track lighting is a method of lighting where light fixtures are attached anywhere on a continuous track device which contains electrical conductors. This is in contrast to directly routing electrical wiring to individual light positions. Track lighting is usually combined with directional lamps with reflectors, such as spotlights.

FEATURES :

- There are also adapters that allow for various track layout configurations; corners ("L") and branches ("T") are the most common.
- Wattage: 150
- Finish: White and Black
- Voltage: 120V AC
- Medium base
- It can be used with all Medium Based Lamps

PAR-16

PAR-20

PAR-30

PAR-38



BR-20

BR-30

BR-40



DIMENSION :

unit:inch

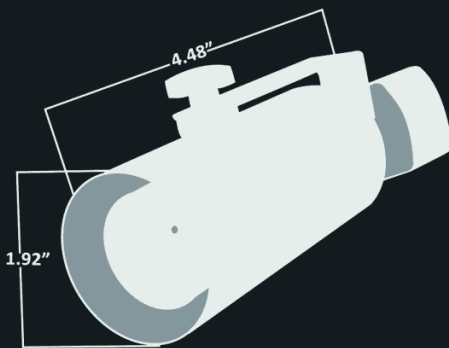

ACCESSORIES

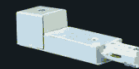

CONDUIT CONNECTOR

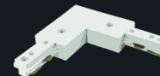

L CONNECTOR FOR TRACK

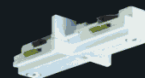

STRAIGHT I CONNECTOR

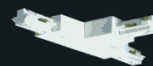

T JOINER/CONNECTOR



TRACK LIGHTING RAILS

MODEL	POWER	FINISH	FIXTURE TYPE	INPUT VOLTAGE RANGE	AVAILABILITY
NUVO-TH227-UNI HOLDER-BK	150W	BLACK	INDOOR	120VAC	IN STOCK
NUVO-TH226-UNI HOLDER-WH		WHITE			



scan to buy

BLUE ELECTRICAL BOX

DESCRIPTION :

Our Blue Electrical Box is a non-metallic PVC switch and outlet box. All four models adhere to the specifications outlined in Article 314 of the NEC. They are fire resistant for 2 hours and hold a UL Listing to ensure safety.

FEATURES :

- Designed to fit standard receptacle outlets and switches.
- Made with non-conductive and rust-resistant PVC thermoplastic.
- Integrated cable clamps.
- Captive nails are included with New Construction Models.
- Complies with US Standard.
- Flame Retardant (2-hour rating).
- Crush Resistant.
- Explosion Resistant.

APPLICATIONS :

- Old Work/New Work (Remodel & New Construction)
- Electrical Receptacle
- Indoor & Outdoor
- HVAC Installations
- Data Networks
- Renovation Projects
- Electrical Panels

DIMENSIONS :

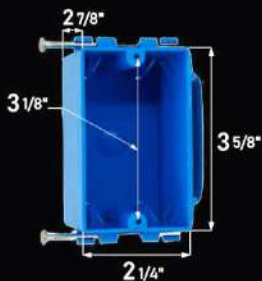

- New Construction 1 Gang
- 18 cu. in. (cubic inches)
- SKU: NUR-JB-N-1GANG

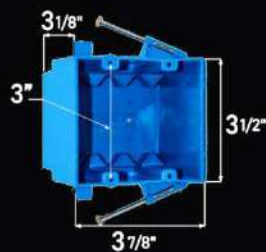

- New Construction 2 Gang
- 32 cu. in. (cubic inches)
- SKU: NUR-JB-N-2GANG

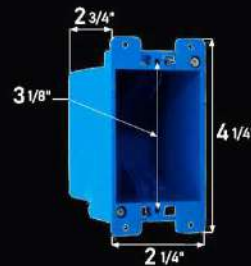

- Remodel Gang 1
- 14 cu. in. (cubic inches)
- SKU: NUR-JB-R-1GANG

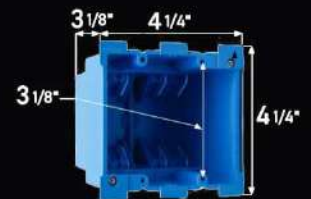

- Remodel Gang 2
- 25 cu. in. (cubic inches)
- SKU: NUR-JB-R-2GANG

18 CU. IN.



25 CU. IN.



scan to buy

INTEGRATED JUNCTION BOX DOWNLIGHT

DESCRIPTION :

The innovative separable design of junction box and housing makes it more flexible. The split commercial downlight can fulfill a wide range of lighting needs. Easy-fit installation comes from adjustable spring-action housing clips. It is designed and engineered for new construction applications, which is suitable for commercial and public places and elegantly decorates the ambience, such as shopping mall, hospital, airport, hotel lobby, etc.

FEATURES :

- Material: Aluminum haze trim with white trim ring
- Mounting: Recessed
- Simple Installation with spring-action housing clips
- Integrated J-Box for direct wire eliminated recessed can
- Perfect and economic solution for new construction applications



CCT Tunable
3000K, 3500K, 4000K



Wattage Tunable
27W/34W/40W

APPLICATIONS :

Suitable for commercial and public places and elegantly decorates the ambience, such as:

- Shopping malls
- Hospitals
- Airports
- Hotel lobbies

DIMENSION :

unit: inches

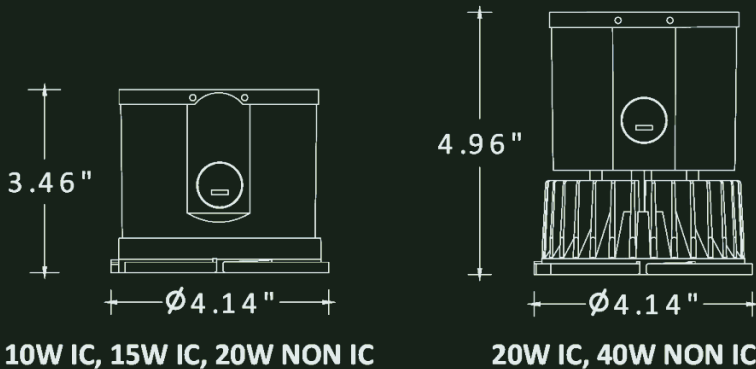

ACCESSORIES

- ROUND TRIM
- NUR-CP-TRIM-R
 - NUR-CP4-TRIM-R
 - NUR-CP6-TRIM-R
 - NUR-CP8-TRIM-R
 - NUR-CP10-TRIM-R



- ROUND WASH WALL TRIM
- NUR-CP-TRIM-RWW
 - NUR-CP4-TRIM-RWW
 - NUR-CP6-TRIM-RWW



- SQUARE TRIM
- NUR-CP-TRIM-S



- SQUARE WALL WASH TRIM
- NUR-CP-TRIM-SWW



- Constructional Frame Kit
- NUR-CP-FRAME



scan to buy

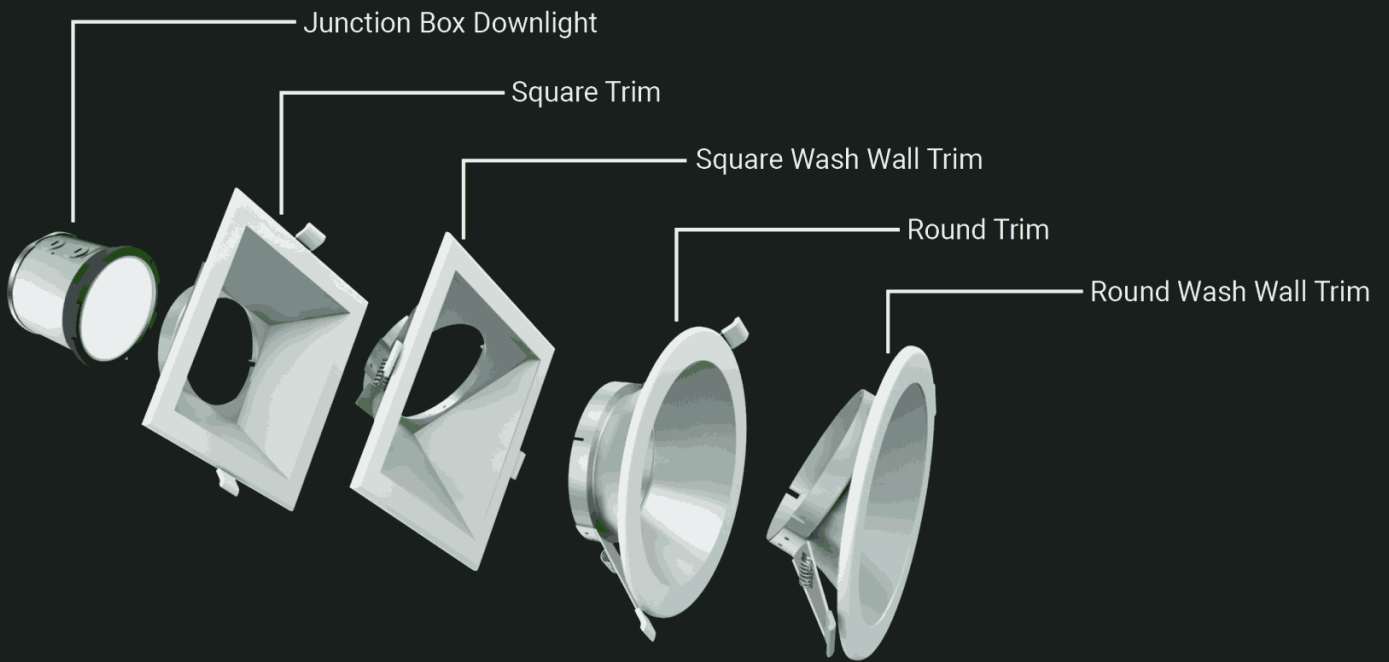

MODEL	COLOR TEMPERATURE	POWER	LUMEN OUTPUT	TRIMS OPTIONS	INPUT VOLTAGE RANGE	AVAILABILITY
DWN-CPS-D10W-CCT	CCT ADJUSTABLE 3000K, 4000K, 5000K	10W	700 LM	4", 6", 8", 10"	120-347VAC	IN STOCK
DWN-CPS-D15W-CCT		15W	1,200 LM			
DWN-CPS-D20W-CCT		20W	1,500 LM			
DWN-CPS-XXW-CCT	XXW	2,700 LM, 3230 LM, 3600 LM				



scan to buy

FLAT T-GRID LINEAR

DESCRIPTION :

Featuring new generation green led lighting solutions, T-Grid linear LED light fixtures with milky diffusing have an added unique combination of direct and indirect illumination, enlarging the lumen spread over the entire space with beam angle of 120°. These linear LED luminaries deliver up to 130 LM/W. They are available in 2ft and 4ft sizes which can fit in standard T-Grid suspended ceilings systems

FEATURES :

- Flexible separable design of LED module and T-Grid bracket
- Seamless continuous runs
- Remote driver with RJ45 terminal
- Fit most ceiling type, like Prelude XL
- Tested Dimmers: Lutron® Diva-Dvtv, Leviton® IP-710-D
- 1 driver can be used for 3 lights
- Plenum rated cable option available
- Custom patern available
- 24V DC option available
- Emergency option available
- CCEA option available



APPLICATIONS :

Flat T-Grid linear LED fixture is used for commercial and institutional environments which requires unique and elegant architectural lighting design, including :

- Office Buildings
- Educational Institutions
- Retail Stores
- Hotels
- Airports
- Hospitals

DIMENSION :

unit: inch

9/16" FLAT

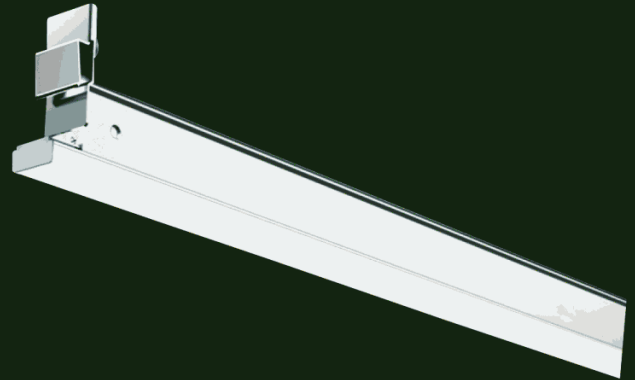
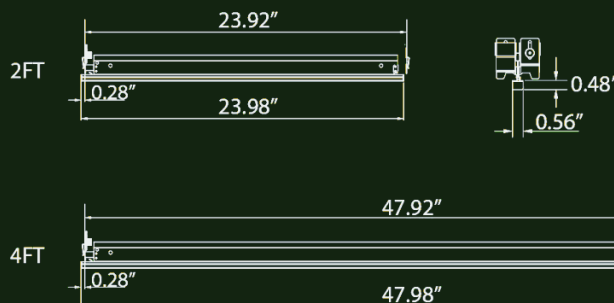

ACCESSORIES

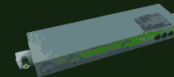

DRIVER
POWER SUPPLY



scan to buy

DIMENSION :

unit:inch

15/16" FLAT

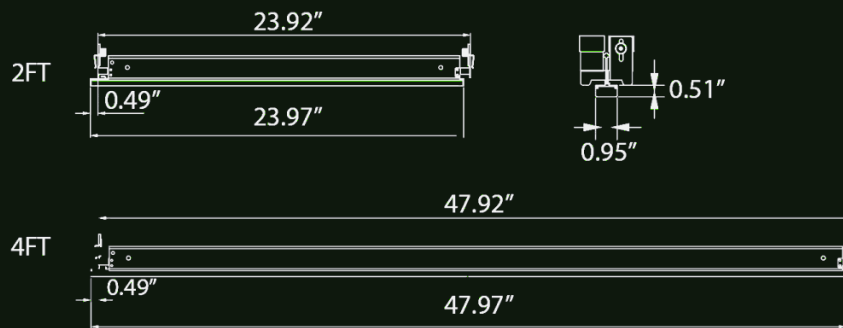

MODEL	COLOR TEMPERATURE	POWER	SIZE	LUMEN OUTPUT	TYPE	INPUT VOLTAGE RANGE	AVAILABILITY
NUR-TB2-DM-35F	3500K	10W	2FT.	1,150 LM	9/16"	DC 36V	IN STOCK
NUR-TB4-DM-35F		20W	4FT.	2,400 LM			
NUR-TB2-DM-40F	4000K	10W	2FT.	1,150 LM			
NUR-TB4-DM-40F		20W	4FT.	2,400 LM			
NUR-TB2-DM-35U	3500K	10W	2FT.	1,300 LM	5/16"	DC 36V	IN STOCK
NUR-TB4-DM-35U		20W	4FT.	2,600 LM			
NUR-TB2-DM-40U	4000K	10W	2FT.	1,300 LM			
NUR-TB4-DM-40U		20W	4FT.	2,600 LM			



scan to buy

ZETA SLIM LINEAR PENDANT LIGHTING

DESCRIPTION :

This slim long suspended pendant fixture is perfect for contemporary and modern commercial workplaces. It can provide smooth continuous runs or be designed into patterns. Usefull for uplight, downlight, direct or indirect lighting distribution. It can also be surface mounted. It is only 1.3 inches wide and comes in 2ft, 4ft and 8ft lengths.

FEATURES :

- Dry and T-Grid ceiling compatable
- Tested Dimmers: Lutron® Diva-Dvtv, Leviton® IP-710-D
- Driver: Internal
- Efficacy (base on up and down light distribution with 3500K): 105LM/W, 1050LM/FT for diffuser and 120LM/W, 1200LM/FT for Micro Reflector
- Selection of Professional Lenses available
- External driver with 110-347V option available
- Optional Functions: Emergency, Sensor



DIMENSION :

unit: inch

Zeta 2 FT

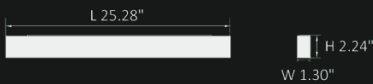

Zeta 4 FT

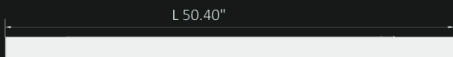

Zeta 8 FT

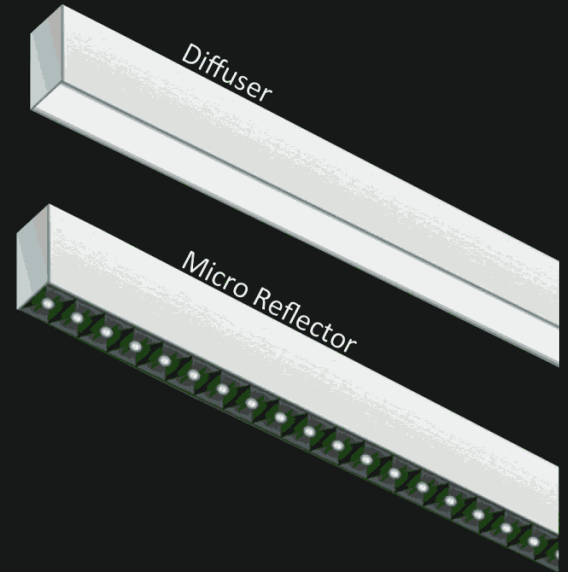
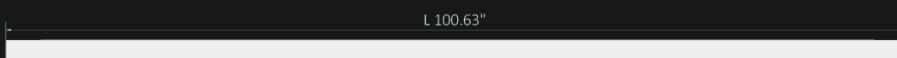

ACCESSORIES



DRY CEILING
2" & 4" ROUND CANOPY



DRY CEILING
2" & 4" SQUARE CANOPY



DROP CEILING
T-GRID HANGER
2" & 4" ROUND CANOPY



DROP CEILING
T-GRID HANGER
2" & 4" SQUARE CANOPY



scan to buy

MOUNTING OPTIONS:

- Pendant
- Surface Mounted
- Wall Mounted

JOINERS:

" I " JOINER (I)
NUR-ZE-CONN-I

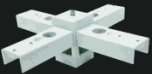

" + " JOINER (CROSS)
NU-ZE-CONN-CROSS



" T " JOINER (CROSS)
NUR-ZE-CONN-T

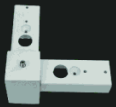

" L " JOINER (CROSS)
NUR-ZE-CONN-L

MODEL	COLOR TEMPERATURE	POWER	SIZE	LUMEN OUTPUT	INPUT VOLTAGE RANGE	AVAILABILITY
NUR-ZE-21-I-35DD	3500K, 4000K	20W	2' length, 1" width	1,800 LM	100-277VAC	IN STOCK
NUR-ZE-21-I-35AD				2,100 LM		
NUR-ZE-21-I-40DD				1,800 LM		
NUR-ZE-21-I-40AD				2,400 LM		
NUR-ZE-21-I-35AR				2,400 LM		
NUR-ZE-41-I-35DD	3500K, 4000K	40W	4' length, 1" width	3,600 LM	100-277VAC	IN STOCK
NUR-ZE-41-I-35AD				4,200 LM		
NUR-ZE-41-I-40DD				3,600 LM		
NUR-ZE-41-I-40AD				4,200 LM		
NUR-ZE-41-I-35AR				4,800 LM		
NUR-ZE-81-I-35DD	3500K, 4000K	80W	8' length, 1" width	7,200 LM	100-277VAC	IN STOCK
NUR-ZE-81-I-35AD				4,800 LM		
NUR-ZE-81-I-40DD				7,200 LM		
NUR-ZE-81-I-40AD				4,800 LM		



HIGHBAY

LED high bay lights are specialized industrial shop lights designed to illuminate large areas with high ceilings. The lights create powerful illumination at a long range and are made to enhance visibility and focus light more directly than traditional incandescent fixtures.



CONTENT:

PAGE NO#

▪ LED Linear Highbay 1	33
▪ LED Linear Highbay 2	34
▪ LED UFO Highbay Watt. and CCT Adjustable	35
▪ Genesis Highbay	36

LED Linear Highbay 1



LED Linear Highbay 2



Genesis Highbay



LED LINEAR HIGH BAY 1

DESCRIPTION :

LED Linear High Bays provide maximum value and performance in a low-profile design. It offers quality lighting and excellent energy savings as compared to fluorescent and HID highbay fixtures.

FEATURES :

- Adjustable CCT (40K/50K)
- Adjustable Power (100%/80%/60%/40%)
- Rugged cold-rolled steel plate corrosion-resistant housing with white coat finish
- Chain, pendant and surface mounting available
- Operating temperature is -40°F to 131°F (-40°C to 55°C)
- Dimmable via 0-10V dimmer

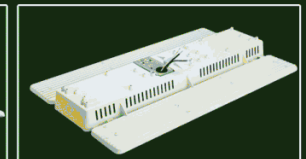
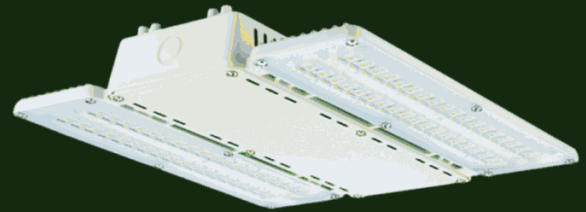

APPLICATIONS :

- Commercial Applications, e.g gymnasium, factories and warehouses
- Retail Applications
- Institutional Applications

DIMENSION :

unit: inch

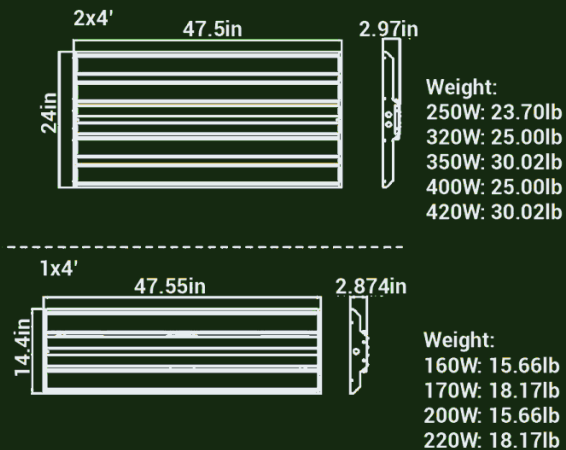

ACCESSORIES

- SENSOR-SCREW ON NUR-PIR SENSOR
- EMERGENCY BATTERY BACKUP NUR-WP-BATTERY
- WIRE GUARD
- PENDANT HANGER

MODEL	COLOR TEMPERATURE	POWER	LUMEN OUTPUT	EFFICACY	SIZES	INPUT VOLTAGE RANGE	AVAILABILITY
NUR-LHB-1*4-200W-CCT-ML-DIM	CCT (4000K, 5000K)	200W	30,000 LM	150 LM/W	1X4 FT.	120-277VAC	SPECIAL ORDER
NUR-LHB-2*4-320W-CCT-ML-DIM		320W	48,000 LM	150 LM/W	2X4 FT.		
NUR-LHB-2*4-400W-CCT-ML-DIM		400W	60,000 LM	150 LM/W	2X4 FT.		

* Special order lead time 3-5 business days



scan to buy

LED LINEAR HIGH BAY 2

DESCRIPTION :

The economic and linear luminaire provides easy installation and replaces linear fluorescent fixtures in new construction or renovations.

FEATURES :

- Rugged cold-rolled steel plate corrosion-resistant housing with white coat finish
- Steel wire rope, pendant or surface mounting available
- Operating temperature is -40°F to 131°F (-40°C to 55°C)
- Dimmable via 0-10 dimmer



APPLICATIONS :

- Commercial Applications, e.g gymnasium, factories and warehouses
- Retail Applications

DIMENSION :

unit: inch

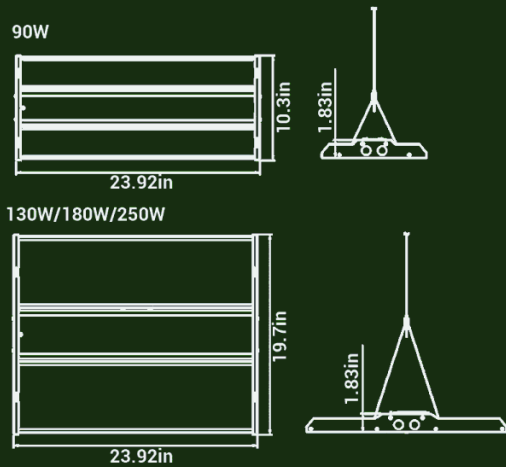

ACCESSORIES



SENSOR-SCREW ON
NUR-PIR SENSOR



EMERGENCY BATTERY BACKUP
NUR-WP-BATTERY



STEEL WIRE ROPE



PENDANT HANGER

MODEL	COLOR TEMPERATURE	POWER	LUMEN OUTPUT	EFFICACY	REPLACES	VOLTAGE	AVAILABILITY
NUR-LHB2-90W-5000K-DIM	5000K	90W	12,600 LM	140 LM/W	(3) F54T5, (4) F32T8 250W HID	120-277VAC 347-480VAC	SPECIAL ORDER
NUR-LHB2-130W-5000K-DIM		130W	18,500 LM	132 LM/W	(4) F54T5, (6) F32T8 400W HID		
NUR-LHB2-180W-5000K-DIM		180W	24,500 LM	136 LM/W	(6) F54T5 (8) F32T8		
NUR-LHB2-205W-5000K-DIM		205W	29,000 LM	141 LM/W	(6) F54TF (8) F32T8		



scan to buy

LED UFO HIGH BAY WATT. & CCT ADJUSTABLE

DESCRIPTION :

The LED High Bay is an economical lighting option. With a CRI of over 80, it provides comfortable and visually appealing lighting.

FEATURES :

- Sealed die-casting profile for indoor and outdoor applications.
- For use with 0-10V dimming, allowing for a dimming range of 100% to 0%.
- An energy-efficient replacement for 250W and 400W metal halide lamps.
- The product is CCT adjustable, allowing for customization of the color temperature.
- It is wattage selectable, providing flexibility in choosing the appropriate power output.

80
CRI



5 year
warranty

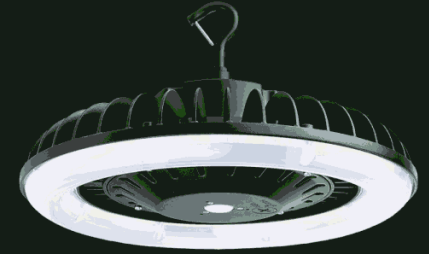

APPLICATIONS :

- Warehouses
- Industrial
- Retail
- Office
- Gymnasiums

DIMENSION :

unit: inch

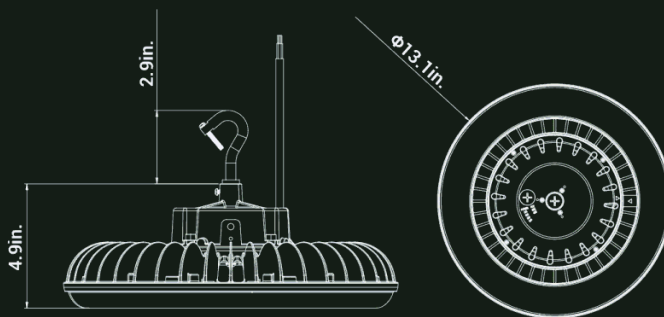

MODEL	COLOR TEMPERATURE	POWER	LUMEN OUTPUT	EFFICACY	REPLACES	VOLTAGE	AVAILABILITY
NUR-HBY-CCT-215W	4000K , 5000K	215W	30500LM , 30300LM	142LM/W , 141LM/W	250W , 400W	120-277V AC	IN STOCK



scan to buy

GENESIS HIGHBAY

DESCRIPTION :

Genesis Highbay is a great fit for low maintenance, energy efficient illumination in large spaces for retail, commercial and industrial applications. They are known for their superior optical design and efficient illumination and can be installed via hook or pendant mounting. Another option to install Genesis is to use a U-bracket. Additionally, reflectors can be used to change the direction of light from the fixture. Aluminum reflector has a parabolic shape and directs light symmetrically in opposite direction. Plastic prismatic reflector casts light in an omni-directional distribution.



FEATURES :

- Die-casting aluminum heatsink with plastic cover
- Operating temperature is -4°F to 131°F (-20°C to 55°C)
- Dimmable via 0-10 dimmer



APPLICATIONS :

- Gymnasiums
- Factories
- Warehouses



DIMENSION :

unit: inch

Net Weight:
100W: 12.3lb
150W: 12.3lb

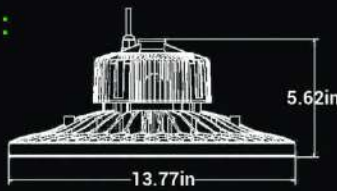

Net Weight:
200W: 16.5lb
240W: 16.5lb
300W: 16.5lb

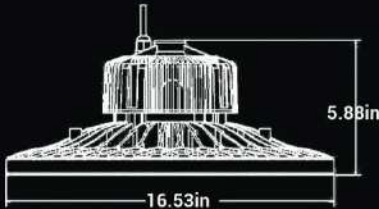

ACCESSORIES



ALUMINUM REFLECTOR

HBY-GENESIS-LENS-ALU-100/150
HBY-GENESIS-LENS-ALU-200/240



PLASTIC REFLECTOR

HBY-GENESIS-LENS-PC-100/150
HBY-GENESIS-LENS-PC-200/240



U-BRACKET

HBY-GENESIS-U Bracket

MODEL	COLOR TEMPERATURE	POWER	LUMEN OUTPUT	EFFICACY	REPLACES	INPUT VOLTAGE RANGE	AVAILABILITY
HBY-GENESIS-100W-5000K-US	5000K	100W	12,000 LM	120 LM/W	300W MH	100-277VAC * 480VAC is available only by Special order	IN STOCK
HBY-GENESIS-150W-5000K-US		150W	18,000 LM		400W MH		
HBY-GENESIS-200W-5000K-US		200W	24,000 LM		500W MH		
HBY-GENESIS-240W-5000K-US		240W	28,800 LM	600W MH			
HBY-GENESIS-300W-5000K-US		300W	42,000 LM	140 LM/W			



scan to buy

COVERED PARKING

Parking lot lighting is a term to describe the outdoor lighting that is commonly mounted on poles and located in parking lots, pathways and driveways. This type of exterior lighting is generally used to provide illumination to areas for vehicle and pedestrian use, with the most frequent attribute being that the light fixtures are mounted to poles.



CONTENT:

PAGE NO#

- Round Canopy Light
- Square Canopy Light

38
39

Round Canopy



Square Canopy



ROUND CANOPY LIGHT

DESCRIPTION :

Our new energy efficient Round Canopy Light is a maintenance-free luminaire and is a great choice for indoor and outdoor applications. A motion sensor can be used for greater energy savings.

FEATURES :

- Adjustable CCT (40K/50K)
- Adjustable Power (60W/46W/34W/22W)
- Sealed die-casting pole for indoor and outdoor applications.
- Operating temperature is -40°F to 113°F (-40°C to 45°C).



APPLICATIONS :

- Parking structures
- Storage areas
- Shopping area walkways
- Entryways
- Low level security

DIMENSION :

unit: inch

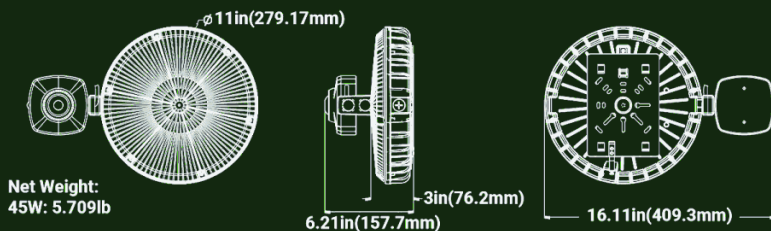
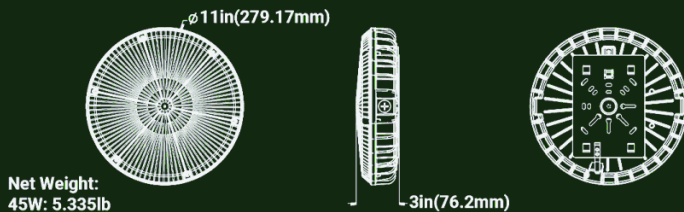

ACCESSORIES

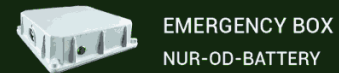

EMERGENCY BOX
NUR-OD-BATTERY



SENSOR-SCREW ON
NUR-PIR SENSOR



UNIVERSAL MOUNTING
PLATE

MODEL	COLOR TEMPERATURE	POWER	LUMEN OUTPUT	EFFICACY	REPLACES	INPUT VOLTAGE RANGE	AVAILABILITY
NUR-CNPY-R-CCT-DIM-WHT	CCT (4000K/ 5000K)	60W	7700LM/7500LM	128LM/W, 125LM/W	175W MH	120-277VAC	IN STOCK
		46W	6500LM/6300LM	141LM/W, 137LM/W			
		34W	5000LM/4900LM	147LM/W, 134LM/W			
		22W	3600LM/3500LM	164LM/W, 159LM/W			



- * 347-480Vac is available only by Special
- * Dark Bronze finish is available in Stock



scan to buy

SQUARE CANOPY LIGHT

DESCRIPTION :

Energy efficient canopy light is designed in a traditional style to be used with current building aesthetics. This maintenance-free luminaire is a great choice for outdoor applications.

FEATURES :

- Sealed Die-casting profile
- Operating temperature is -40°F to 104°F (-40°C to 40°C)

70 CRI  5 year warranty

APPLICATIONS :

- Parking structures
- Storage areas
- Shopping area walkways
- Entryways
- Low level security



DIMENSION :

unit: inch

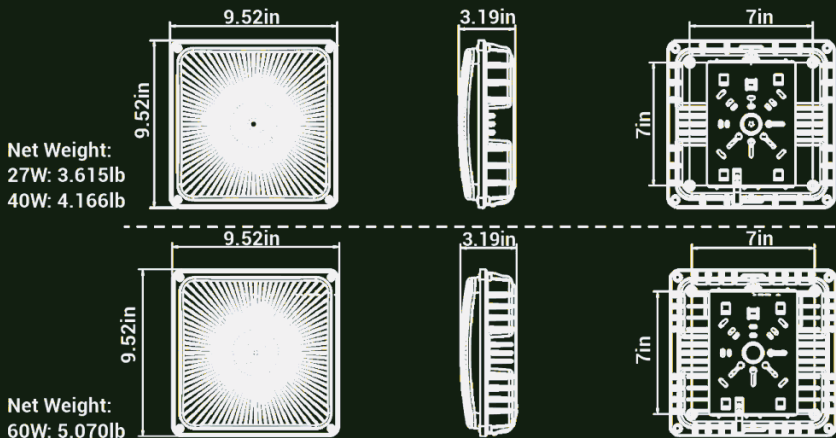

ACCESSORIES



SENSOR-SCREW ON (SPECIAL ORDER)
NUR-PIR SENSOR



EMERGENCY BOX (SPECIAL ORDER)
NUR-OD-BATTERY

MODEL	COLOR TEMPERATURE	POWER	LIGHT OUTPUT	EFFICACY	REPLACES	INPUT VOLTAGE RANGE	AVAILABILITY
NUR-CNPY05-40W-5000K-DIM	5000K	40W	5,450 LM	136 LM/W	175W MH	120-277VAC	IN STOCK
NUR-CNPY05-60W-5000K-DIM		60W	8,000 LM	133 LM/W	250W MH		

- * 347-480Vac is available only by Special order
- * White finish is available on Special order



scan to buy

WALL MOUNTED

Wall-mounted luminaires are mounted directly to a wall surface. This type includes sconces, diffusers, and vanity lights. Wall-mounted luminaires are commonly used in homes because they are easy to install, are available in a wide variety of styles, and accommodate many lamp types.



CONTENT:

PAGE NO#

▪ LED Wall Mount	41
▪ Illustration	42-43
▪ Slim Wall Pack	44
▪ LED Wall Pack	45
▪ Wall Pack (WP04)	46
▪ LED Full Cutoff Wall Pack	47
▪ Dusk To Dawn	48

LED Wall Mount



Slim Wall Pack



LED Wall Pack

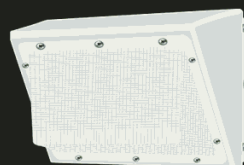

LED Full Cutoff Wall Pack

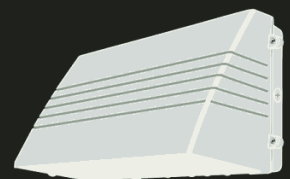

LED WALL MOUNT

DESCRIPTION :

The Wall Mount is designed with a minimalistic form factors for egress applications. Typically found above building exterior exit doors or wall mounted for illumination next to a path of egress, the wall mount comes in a standard dark bronze finish. The poly-carbonate lens helps distribute light evenly while keeping glare to a minimal.

FEATURES :

- Sealed die-casting profile
- Polycarbonate optical lens with UV stabilizers
- For greater energy savings, you can choose to add photocell which comes pre-installed from the factory

70
CRI

WET LOCATION

5 year
warranty

APPLICATIONS :

- Security
- Entry ways
- Stairway
- Storage
- Perimeter areas
- Residential exteriors

DIMENSION :

unit: inch

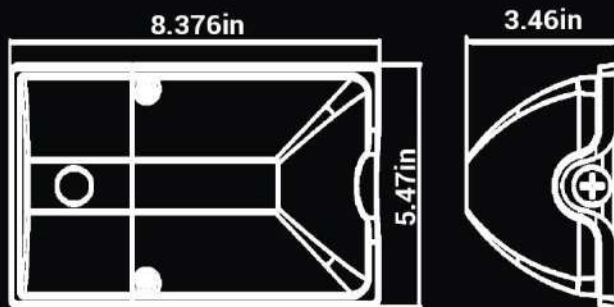

Weight:
15W/17W: 1.931lb
25W: 2.015lb



ACCESSORIES



PHOTOCELL
CONT-Photocell - Button,

MODEL	COLOR TEMPERATURE	POWER	LUMEN OUTPUT	EFFICACY	REPLACES	INPUT VOLTAGE RANGE	AVAILABILITY
NUR-WM-17W-5000K-PC1	5000K	17W	1,700 LM	115 LM/W	120W INCANDESCENT	120-277VAC	SPECIAL ORDER
NUR-WM-25W-5000K-PC2		25W	2,600 LM	104 LM/W	50W MH		



* Special order lead time 3-5 business days



scan to buy

LIGHT COVERAGE

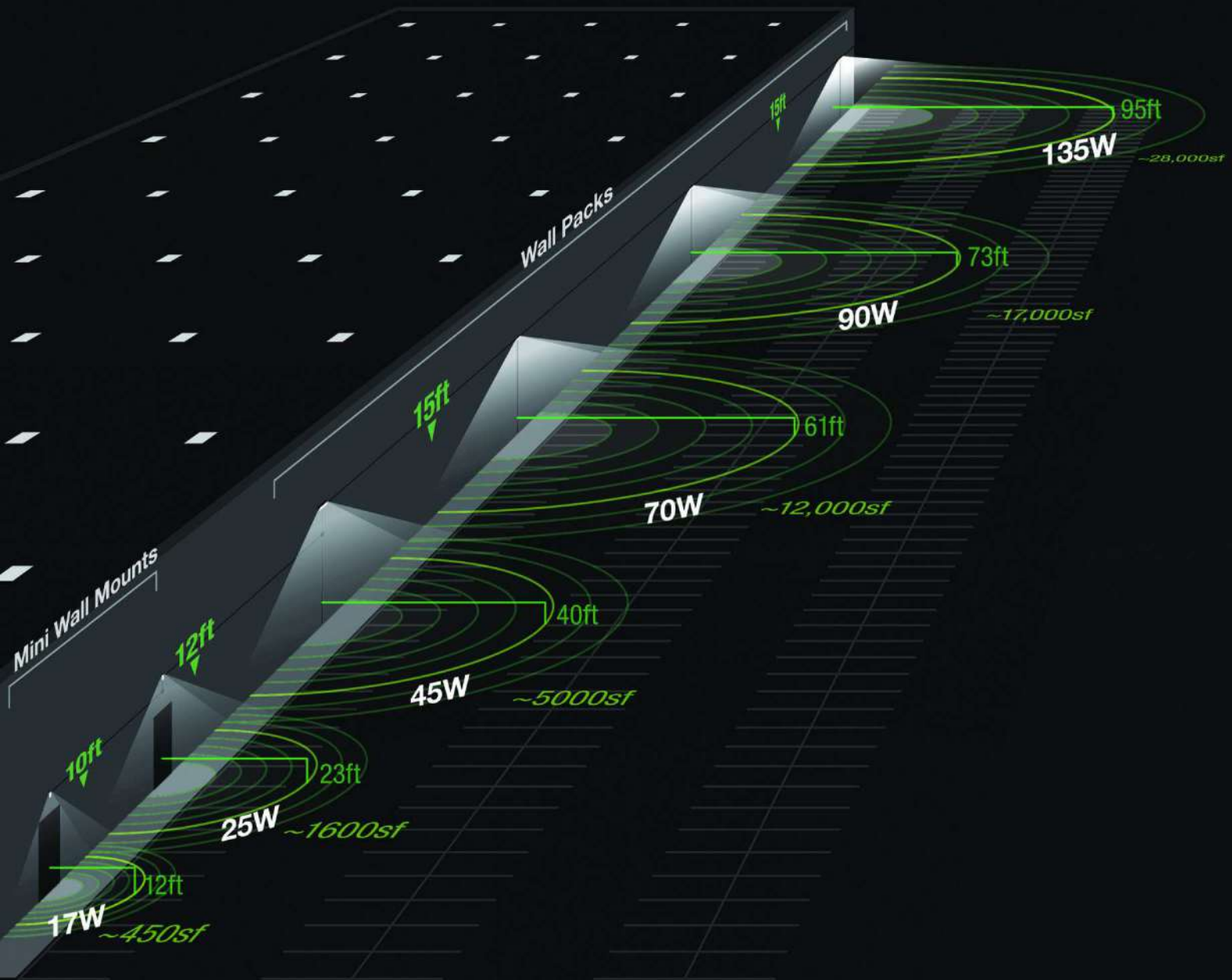

What is a footcandle?

A footcandle is a measurement of the amount of light hitting a surface.

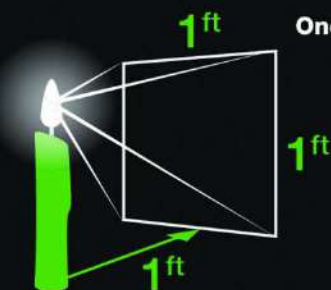

One footcandle is the amount of light **one candle** casts on a **one foot by one foot** square **one foot** away.

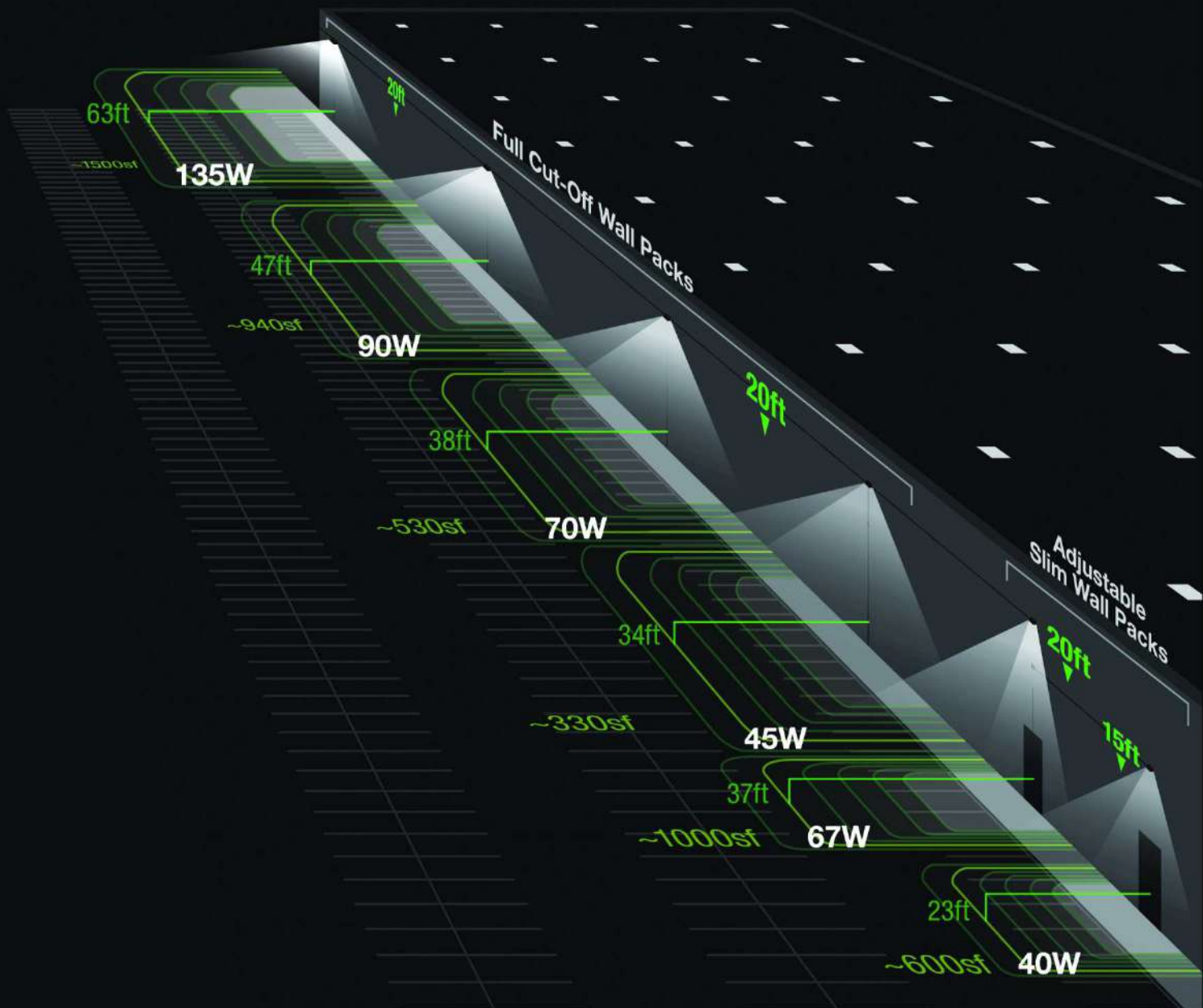

How much light is needed?

The standard for lighting in an open-air parking lot, with average activity, in an urban zone, is a range of maintained illuminance of a minimum of 0.75 footcandles (**0.75 fc**) to a maximum of 3 footcandles (**3 fc**).

This standard is set by the Illuminating Engineering Society (IES), an accredited Standards Development Organization (SDO) under American National Standards Institute (ANSI) approved procedures.

SLIM WALL PACK

DESCRIPTION :

The classic architectural fixture is designed to keep out dust and moisture using a single piece solid silicone gasket. Well crafted reflector optics allows the light engine to be recessed within the luminaire, providing visual comfort and superior distribution.

FEATURES :

- Rugged die-cast aluminum, corrosion resistant housing with dark bronze polyester powder coat finish
- 0 to +40° tilt adjustments



APPLICATIONS :

- Security and Pathway
- Perimeter lighting
- Building entryways
- Walkways

DIMENSION :

unit: inch

Small size: 27W/40W

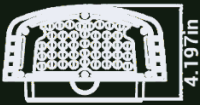
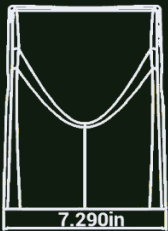

Net Weight:
27W: 3.351lb
40W: 3.968lb

Medium size: 67W/80W

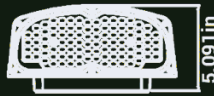
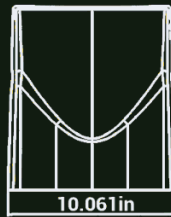

Net Weight:
67W: 7.319lb
80W: 7.804lb

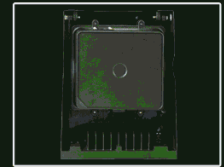
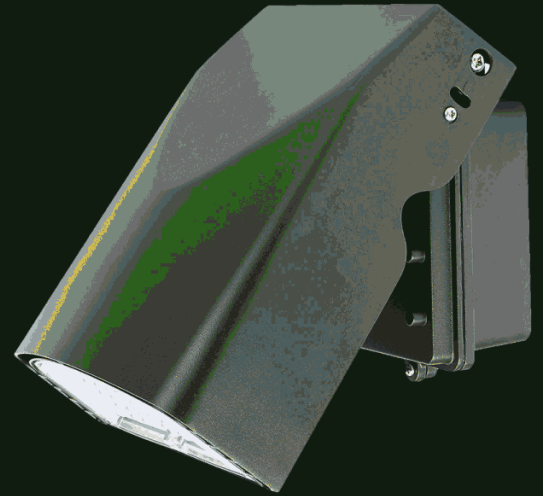

ACCESSORIES

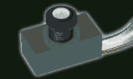

PHOTOCELL
CONT-Photocell - Button,

MODEL	COLOR TEMPERATURE	POWER	LUMEN OUTPUT	EFFICACY	REPLACES	INPUT VOLTAGE RANGE	AVAILABILITY
NUR-WP-S-27W-5000K	5000K	27W	3,600 LM	133 LM/W	100W MH	120-277VAC	IN STOCK
NUR-WP-S-40W-5000K		40W	5,200 LM	130 LM/W	175W MH		
NUR-WP-S-67W-5000K		67W	8,800 LM	131 LM/W	250W MH		
NUR-WP-S-80W-5000K		80W	3,600 LM		320W MH		

* 347-480Vac is available only by Special order



scan to buy

LED WALL PACK

DESCRIPTION :

Cast in a traditional design, Wall packs offer a popular, classic appearance with energy-efficient LED technology. Available in power wattage range of 30W-135W. It can be used for both, indoor and outdoor applications.

FEATURES :

- Sealed die-cast aluminum, corrosion resistant housing with dark bronze polyester coat finish
- Polycarbonate optical lens with UV stabilizers
- Operating temperature: -40°F to 104°F (-40°C to 40°C)



APPLICATIONS :

- Security
- Walkways
- Pathways
- Building entryways
- Perimeter Lighting



DIMENSION :

unit: inch
Medium Size



Large Size

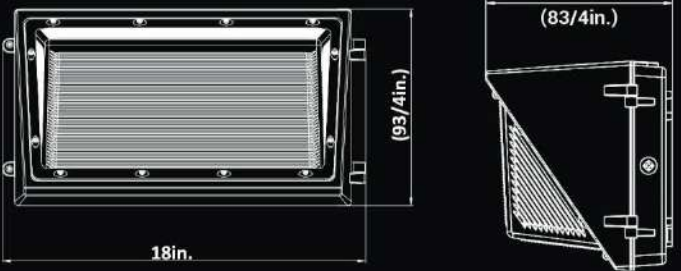

ACCESSORIES



PHOTOCELL
CONT-Photocell - Button,

MODEL	COLOR TEMPERATURE	POWER	LUMEN OUTPUT	EFFICACY	REPLACES	INPUT VOLTAGE RANGE	AVAILABILITY
NUR-WP-30W-5000K	5000K	30W	3,400 LM	113 LM/W	100W MH	120-277VAC	SPECIAL ORDER
NUR-WP-40W-5000K		40W	5,300 LM	117 LM/W	175W MH	* 347-480 input voltage is available only by Special order	
NUR-WP-65W-5000K		65W	8,100 LM	115 LM/W	250W MH		IN STOCK
NUR-WP-90W-5000K		90W	11,200 LM	124 LM/W	320W MH		



scan to buy

WALL PACK (WP04)

DESCRIPTION :

As versatile as it is efficient, WP04 is designed to replace up to 250W-400W metal halide while saving up to 87% in energy costs. The brand new WP04 series provides enhanced end-user experiences and unmatched energy savings the long life LEDs and drivermake this fixture nearly maintenance-free.

FEATURES :

- Sealed die-casting profile for outdoor applications.
- Casting thermally conducts LED heat to optimize performance and long life.
- Color temperature adjustable: 3000K/4000K/5000K.
- Scalable Lumen Packages from 3,600 to 12,500 Lumens
- Universal 120-277 to 347-480 VAC input voltage.
- 1-10 Dimming option
- Operating Temperature Range -40°F- 104°F
- Estimated 50,000 hours LED lifespan



APPLICATIONS :

- Roadways lighting
- Building entrances
- Schools
- Tunnels
- Factories
- Loading docks

DIMENSION :

unit: inch

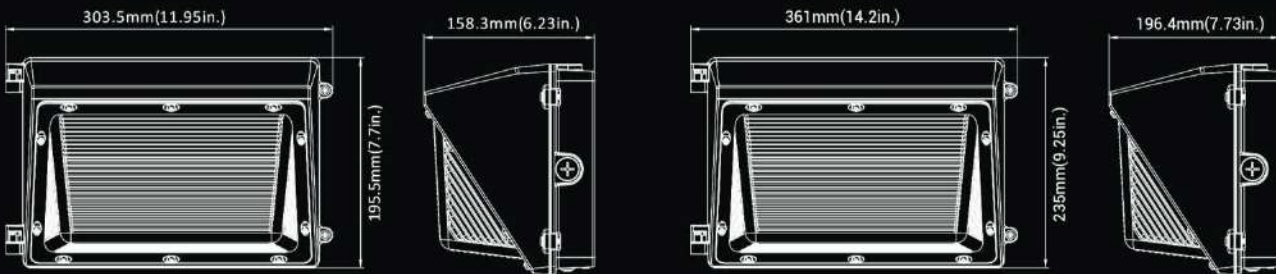

62W

100W



ACCESSORIES:



PHOTOCELL (OPTIONAL)
CONT-Photocell - Button

EMERGENCY BATTERY
BACKUP
NUR-OD-BATTERY

MODEL	COLOR TEMPERATURE	POWER	LUMEN OUTPUT	EFFICACY	INPUT VOLTAGE RANGE	AVAILABILITY
NUR-WP-62W-CCT	(3000K, 4000K, 5000K)	62W	7800LM	125 LM/W	120-277VAC	IN STOCK
NUR-WP-100W-CCT	(3000K, 4000K, 5000K)	100W	12500LM			

* 347-480 input voltage is available only by Special order



scan to buy

LED FULL CUTOFF WALL PACK

DESCRIPTION :

Full cutoff LED Wall Pack, available from 45W-135W, provides durable, efficient light source with maximum performance and minimum maintenance. Suitable for use in both, indoor and outdoor applications. Use of optional photocell allows added security and greater energy saving.

FEATURES :

- CCT Adjustable (30K/40K/50K)
- Adjustable Power (100%/80%/60%/40%)
- Rugged die-cast aluminum, corrosion resistant housing with dark bronze powder coat finish
- Full cutoff and compliance to Dark Sky requirement
- Type III polycarbonate optical lens with UV stabilizers

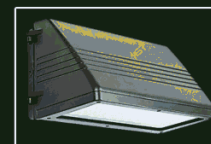
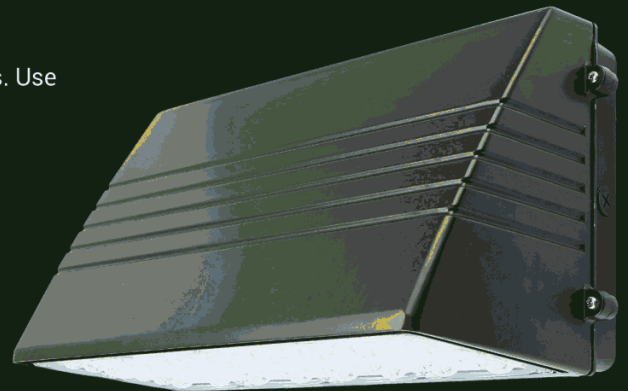

APPLICATIONS :

- Pedestrian parking areas
- Walkways
- Garages
- Stairways
- Pathways
- Building entryways
- Perimeter Lighting

DIMENSION :

unit: inch

Medium Size

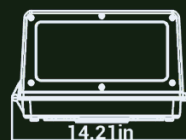
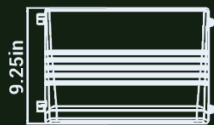

Net Weight
45W: 9.48lb
70W: 9.81lb

Large Size



Net Weight
90W: 12.92lb
135W: 13.03lb

ACCESSORIES

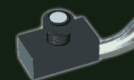

PHOTOCELL
CONT-Photocell - Button,

MODEL	COLOR TEMPERATURE	POWER	LUMEN OUTPUT	EFFICACY	REPLACES	INPUT VOLTAGE RANGE	AVAILABILITY
NUR-WP-45W-CCT	CCT (3000K, 4000K, 5000K)	45W	6232 LM	141 LM/W	175W MH	120-277VAC	IN STOCK
NUR-WP-70W-CCT		70W	9700 LM	139 LM/W	250W MH		
NUR-WP-90W-CCT		90W	12465 LM	137 LM/W	320W MH		
NUR-WP-135W-CCT		135W	19400 LM	133 LM/W	400W MH		



scan to buy

DUSK TO DAWN LIGHT

DESCRIPTION :

LED Dusk to Dawn flood lights emit a wide, even spread of light. They are an ideal, energy efficient solution for security lighting, lighting parameters, backyards and service roads.

FEATURES :

- Plug in photo sensor
- Built in UL class 2 driver



APPLICATIONS :

- Service roads
- For security and parameter lighting purposes

DIMENSION :

unit: inch

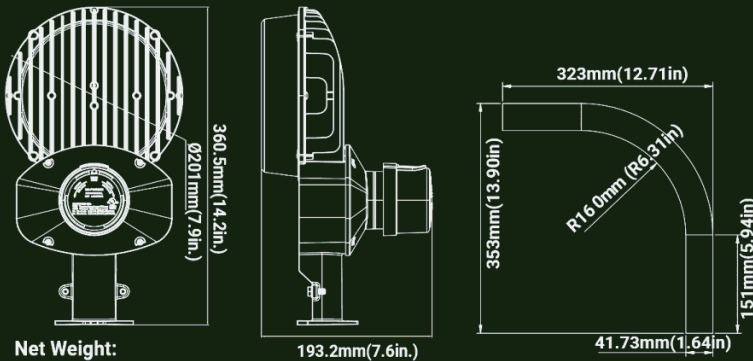

Net Weight:
65W: 4.8038lb
70W: 5.0287lb

ACCESSORIES



MODEL	COLOR TEMPERATURE	POWER	LUMEN OUTPUT	EFFICACY	FINISH	INPUT VOLTAGE RANGE	AVAILABILITY
NUR-D2D-65W-5000K-SG	65W	5000K	7,400 LM	114 LM/W	DARK BRONZE	120-277VAC	SPECIAL ORDER
NUR-D2D-70W-5000K-SG	70W		10,500 LM	117 LM/W	SILVER/GREY		

*Silver/Grey finish is available on Special order



scan to buy

ARCHITECTURAL

Architectural lighting works to serve and enhance the architecture. Architectural lighting is an intersection of art (architecture) and technology (lighting). The architecture being illuminated or lighted may be commercial or residential. Other fields of endeavor, such as design, also come into play.



CONTENT:

- LED Mini Flood Light
- Bullet Light

PAGE NO#

50-51
52

Bullet Light



Mini Flood Light



LED MINI FLOOD LIGHT

DESCRIPTION :

The easy to install trunnion mounts and adjustable knuckle mounts make LED mini flood Light a good choice for small area illumination.

FEATURES :

- Rugged aluminum housing with UV resistant powder coat finish for corrosion protection
- Wide Flood beam
- Operating temperature is -40°F to 113°F (-40°C to 45°C)



70 CRI
WET LOCATION
IP65
5 year warranty

APPLICATIONS :

- Facade
- Wall Washing
- Landscape Lighting
- Poster board lighting
- Building Lighting



DIMENSION :

unit: inch

15W(Knuckle Mount)

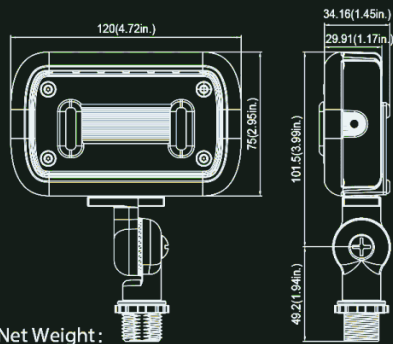

Net Weight :
0.939lb

ACCESSORIES



1/2" KNUCKLE MOUNT

TRUNNION MOUNT

16W(Knuckle Mount)

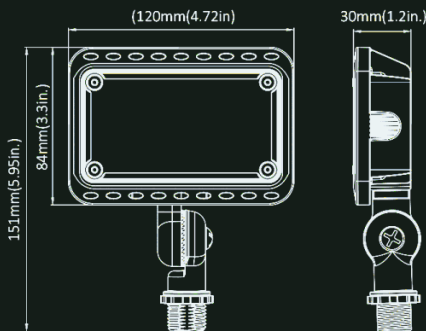

16W(Trunnion Mount)

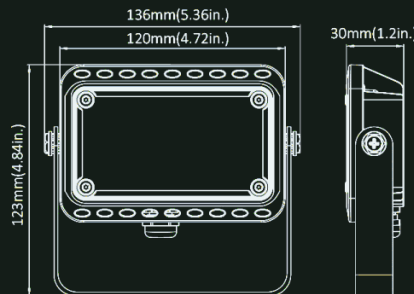

scan to buy

DIMENSION :

unit:inch

30W(Knuckle Mount)

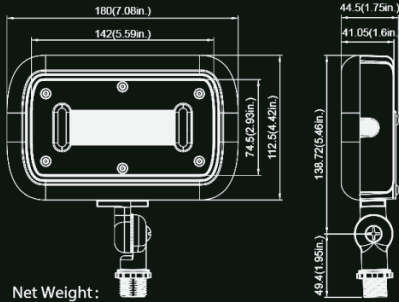

Net Weight :
1.887lb

30W(Trunnion Mount)

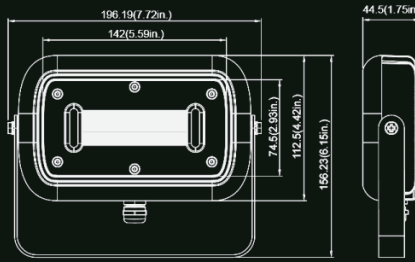

Net Weight :
2.061lb

45W(Knuckle Mount)

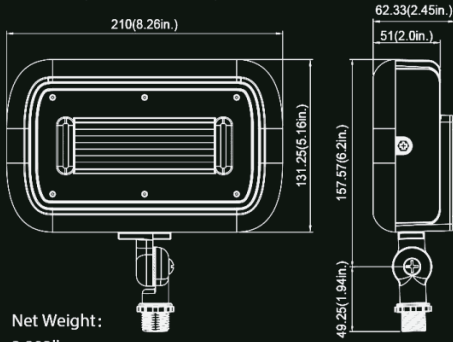

Net Weight :
3.893lb

45W(Trunnion Mount)

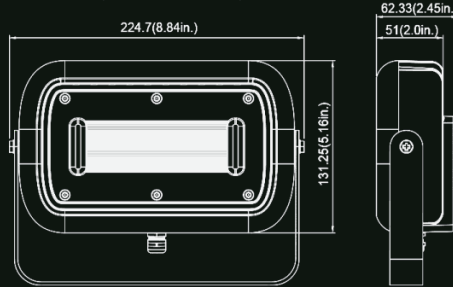

Net Weight :
4.123lb

MODEL	COLOR TEMPERATURE	POWER	LUMEN OUTPUT	EFFICACY	REPLACES	INPUT VOLTAGE RANGE	AVAILABILITY
NUR-FL-MINI-15W-3000K-KM	3000K	15W	1,500 LM	100 LM/W	50W MH	120-277VAC	IN STOCK
NUR-FL-MINI-15W-5000K-KM	5000K						
NIUR-FL-MINI-16W-3000K-KM	3000K	16W	1,500 LM	94 LM/W			
NUR-FL-MINI-16W-4000K-KM	4000K		1,600 LM	100 LM/W			
NUR-FL-MINI-16W-5000K-KM	5000K		1,600 LM	100 LM/W			
NUR-FL-MINI-30W-3000K-TM	3000K	30W	3,000 LM	100 LM/W			
NUR-FL-MINI-30W-3000K-KM							
NUR-FL-MINI-30W-5000K-KM	5000K						
NUR-FL-MINI-45W-3000K-KM	3000K	45W	5,400 LM	120 LM/W	175W MH		
NUR-FL-MINI-45W-5000K-KM	5000K						
NUR-FL-MINI-45W-5000K-TM							



scan to buy

BULLET LIGHT

DESCRIPTION :

The highly efficient, directional Bullet Light is used as landscape and security lighting. Its rugged aluminum housing with UV resistant powder coat finish offers outstanding corrosion protection. Its vented housing isolates LED module from driver maximizing product life and performance.

FEATURES :

- Can be easily mounted using a ½" knuckle mount
- Operating temperature is -40°F~122°F (-40°C to 50 °C)



APPLICATIONS :

- Facade
- Wall Washing
- Landscape lighting
- Poster board lighting
- Flag up lighting.

DIMENSION :

unit: inch

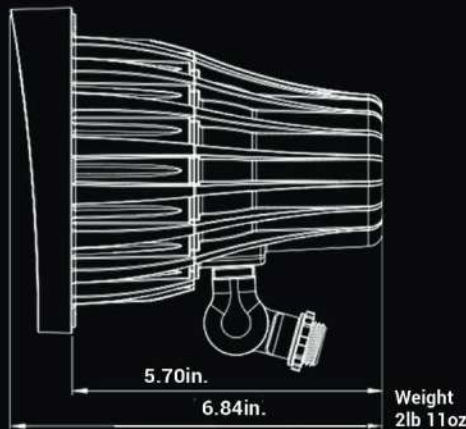
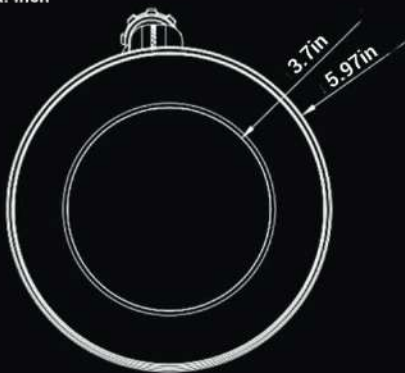

MODEL	COLOR TEMPERATURE	POWER	LUMEN OUTPUT	EFFICACY	REPLACES	INPUT VOLTAGE RANGE	AVAILABILITY
NUR-FL-BULLET-30W-5000K-KM	5000K	30W	3,360 LM	112 LM/W	100W MH	120-277VAC	IN STOCK



scan to buy

PARKING LOTS/POLES

Architectural lighting works to serve and enhance the architecture. Architectural lighting is an intersection of art (architecture) and technology (lighting). The architecture being illuminated or lighted may be commercial or residential. Other fields of endeavor, such as design, also come into play.



CONTENT:

	PAGE NO#
▪ Light Coverage Illustrations	54-55
▪ Lexin	56
▪ Flood Light FL05	57-58
▪ Flood Light-FL08	59
▪ Flood Light-FL11	60
▪ LED Swan Post Light	61
▪ LED Post Top Light	62
▪ Poles	63
▪ Poles Accessories	64-65

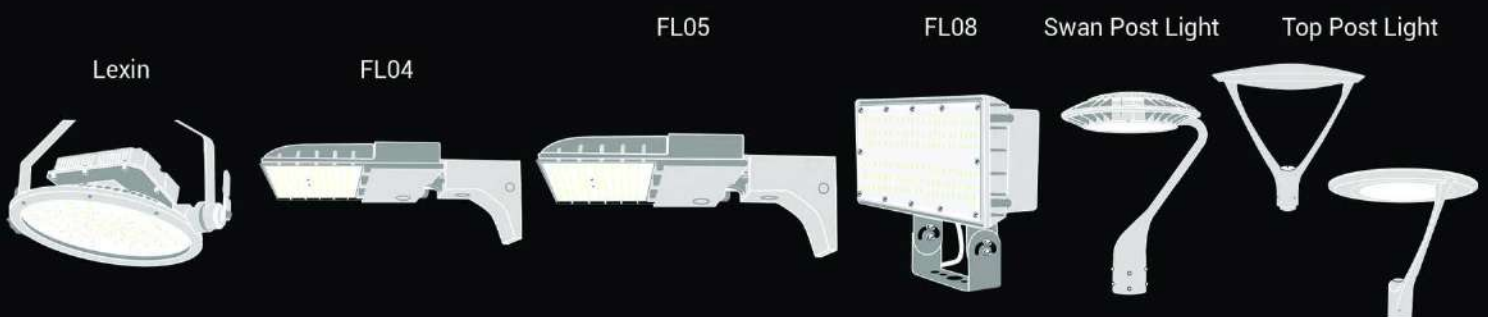

LIGHT COVERAGE

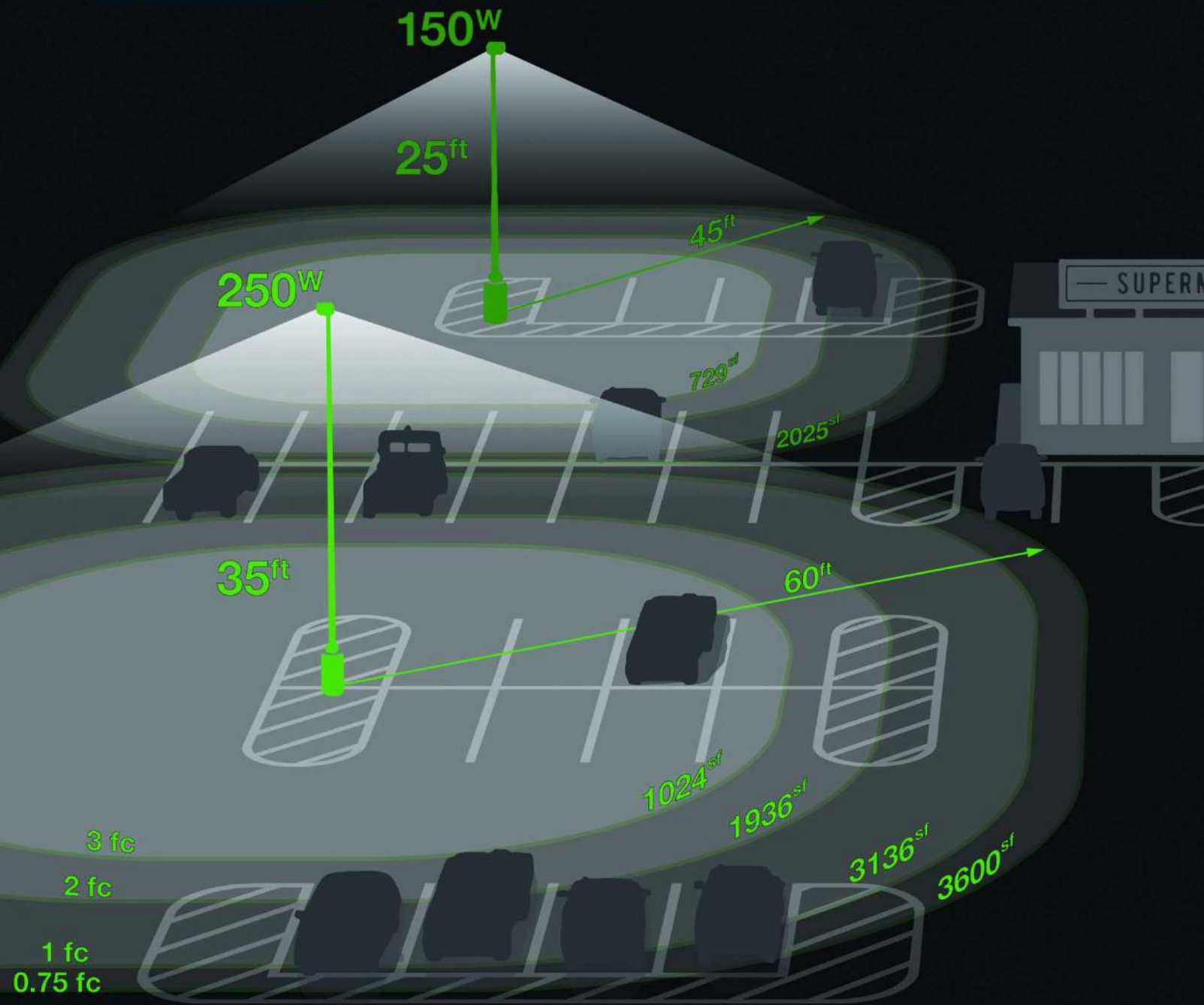

Recommended Brightness for Urban Environments = 3 footcandles (fc) max to 0.75 footcandles (fc) min

What is a footcandle?

A footcandle is a measurement of the amount of light hitting a surface.

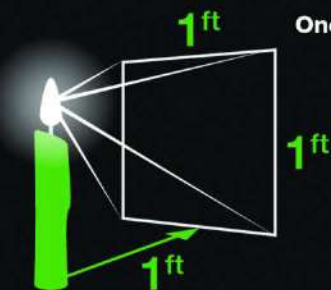

One footcandle is the amount of light **one candle** casts on a **one foot by one foot** square **one foot** away.

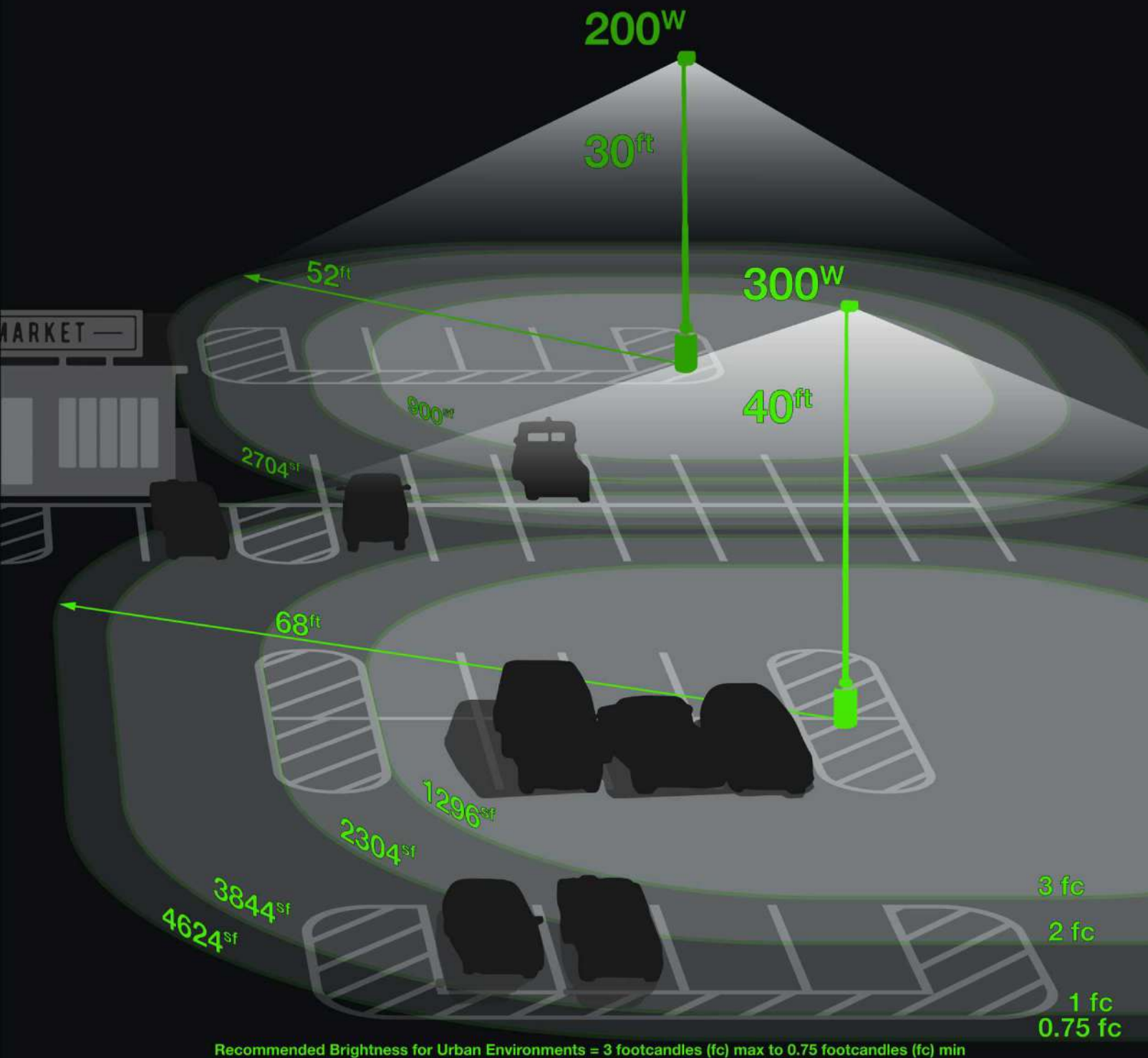

How much light is needed?

The standard for lighting in an open-air parking lot, with average activity, in an urban zone, is a range of maintained illuminance of a minimum of 0.75 footcandles (**0.75 fc**) to a maximum of 3 footcandles (**3 fc**).

This standard is set by the Illuminating Engineering Society (IES), an accredited Standards Development Organization (SDO) under American National Standards Institute (ANSI) approved procedures.

LEXIN

DESCRIPTION :

Slim profile, high output lexin is used for applications ranging from ceiling mounted highbay or pole mounted street or parking lot lighting to security lighting for buildings. The fixture is available as special order and you can get your customized lexin by choosing a set of parameters, including lumen output, wattage and beam angle.

FEATURES :

- Made from rugged die-cast aluminum with weather tight seals
- Shock and vibration safe
- Optical options:
 - Flood - 60°, 180° (No Optics)
 - Dome - 200°



APPLICATIONS :

- High Bay Lighting
- Light Tower Lighting
- High Mast Lighting

DIMENSION :

unit:inch

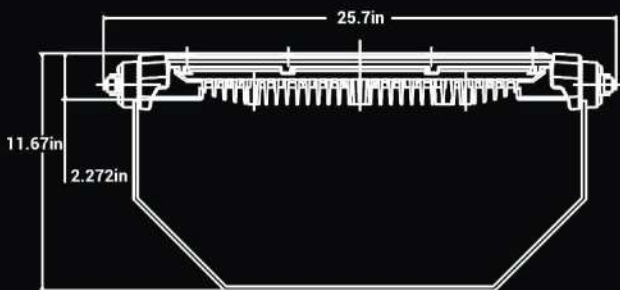

ACCESSORIES



SHROUD



DOME



DRIVER HOUSING

MODEL	COLOR TEMPERATURE	POWER	LUMEN OUTPUT	EFFICACY	INPUT VOLTAGE RANGE	AVAILABILITY
LEX-450-60D	5000K	320W	45,000	140 LM/W	100-277VAC	IN STOCK
LEX-500			50,000	157 LM/W	300-480VAC	

+ Special order lead time 3-5 business days



scan to buy

LED FLOOD LIGHT FL05

DESCRIPTION :

FL10s are designed to provide superior performance and efficacy for exterior applications. An integral power supply with universal 120-277V or 347-480Vac input voltage and 1-10V dimming makes installation simple.

FEATURES :

- Die-cast aluminum housing with UV resistant polycarbonate optical lens provides corrosion protection
- Finish: Dark Bronze
- Moduler bracket design allows for easy installation bracket with a rail side installation to the fixture. Install time is cut down by 75% when compared to other LED fixtures.
- Operating temperature is -40°F to 113°F (-40°C to 45°C)



100W

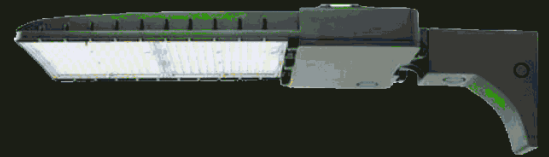

250W/300W



APPLICATIONS :

- Facade
- Wall Washing
- Landscape Lighting
- Poster board lighting
- Building Lighting

DIMENSION :

unit: inch

ACCESSORIES:

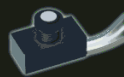

PHOTOCELL
CONT-Photocell - Button



YOKE MOUNT
NUR-MNT10-TM/YK-BNZ



WALL MOUNT
NUR-MNT10-WM-BNZ



SLIPFITTER MOUNT
NUR-MNT10-TM/TR-BNZ



TRUNNION MOUNT
NUR-MNT10-TM/TR-BNZ

Slipfitter Mount (100W)

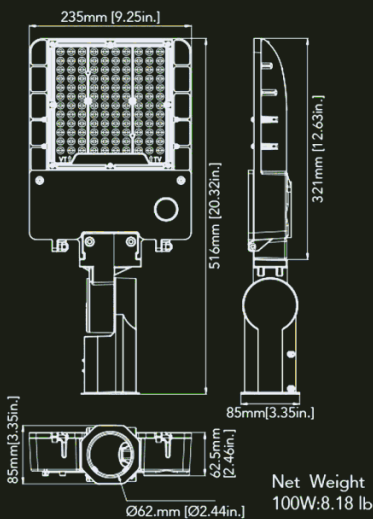

Wall Mount (100W)

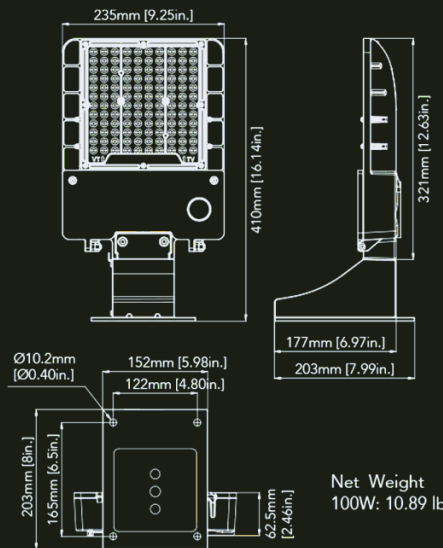

Pole Mount (100W)

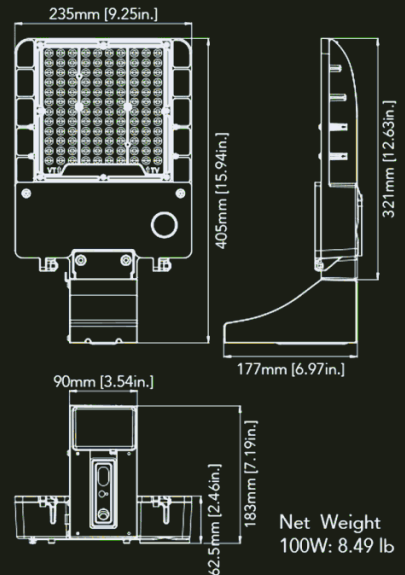

scan to buy

YOKE
MOUNT

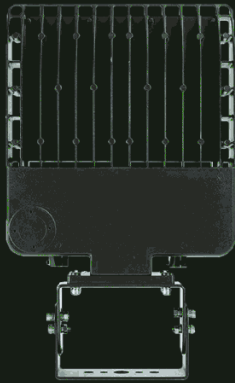

SLIPFITTER
MOUNT



TRUNNION
MOUNT

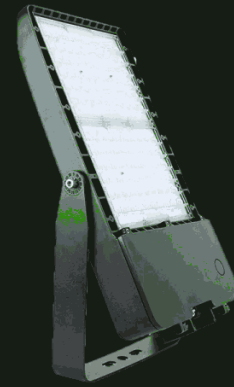

DIMENSION :

unit: inch

Slipfitter Mount (250W&300W)

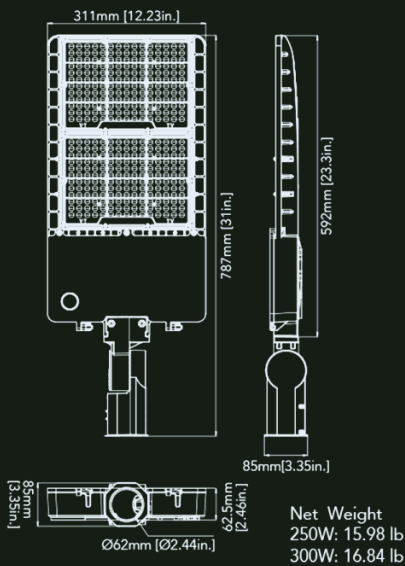

Wall Mount (250W&300W)

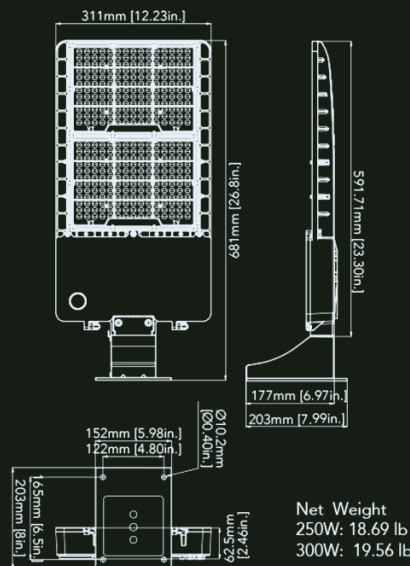

Pole Mount (250W&300W)

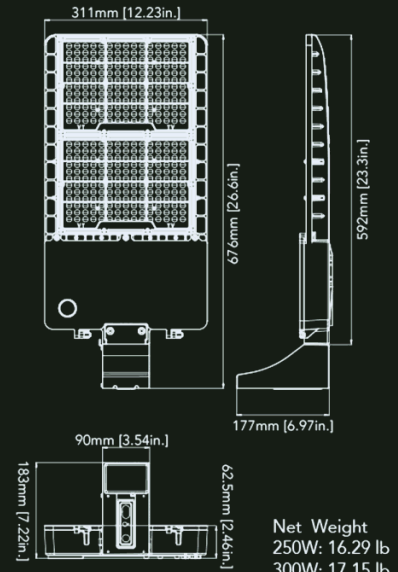

MODEL	COLOR TEMPERATURE	POWER	LUMEN OUTPUT	EFFICACY	REPLACES	INPUT VOLTAGE RANGE	AVAILABILITY
NUR-FL05-100W-5000K	5000K	100W	14200 LM	142 LM/W	320W MH	347-480VAC	SPECIAL ORDER
NUR-FL05-250W-5000K		250W	35000 LM	140 LM/W	400W MH		
NUR-FL05-300W-5000K		300W	42000 LM		530W MH		



scan to buy

FLOOD LIGHT-FL08

DESCRIPTION :

Flood Light-FL08 is a high performance LED lighting solution designed with optical versatility and a slim, low profile design. Its rugged cast aluminum housing minimizes wind load requirements and features an integral, watertight LED driver compartment with high performance aluminum heat sinks.

FEATURES :

- Housing, electrical compartment and filter are all made from die cast aluminum that is pre-heated and powder coated to meet the most rugged industry standards
- Vented housing isolates LED driver module from driver, maximizing product life and performance
- Optics (NEMA Type): 7H*6V

70 CRI 5 year warranty WET LOCATION

APPLICATIONS :

- Parking lots
- Walkways
- Campuses
- Car dealerships
- Office complexes
- Internal roadways

DIMENSION :

unit: inch

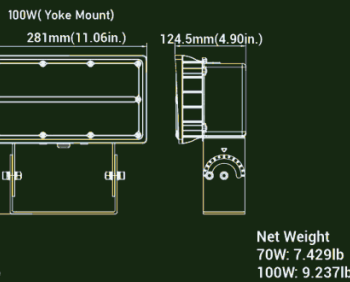
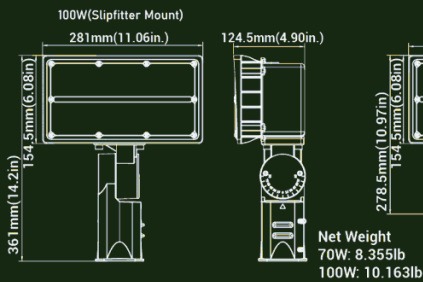
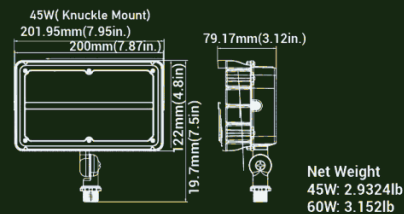

ACCESSORIES



PHOTOCELL
CONT-Photoeye - Button,

MODEL	COLOR TEMPERATURE	POWER	LUMEN OUTPUT	EFFICACY	REPLACES	INPUT VOLTAGE RANGE	AVAILABILITY
NUR-FL08-45W-5000K-KM	5000K	45W	5,650 LM	126 LM/W	175W MH	120-277VAC	IN STOCK
NUR-FL08-100W-5000K-SF		100W	13,300 LM	133 LM/W	320W MH		
NUR-FL08-100W-5000K-YK		100W					



scan to buy

FLOOD LIGHT-FL11

DESCRIPTION :

Flood Light-FL11 aims to provide customers with an economical, efficient, flexible, and long-life flood light. The low-profile and stylish exterior design can be well integrated into various architectural environments.

FEATURES :

- Die-Cast aluminium optimizes the best heat dissipation management as the main part of the fixture, which effectively improves the LED efficiency
- Durable surface coating powder spraying and fully sealed tempered glass can extend the durability of the fixture
- CCT Selectable 3000K, 4000K, and 5000K
- Optics (NEMA Type): 7H*7V



APPLICATIONS :

- Courtyards
- Driveways
- Buildings
- Billboards

DIMENSION :

unit: inch

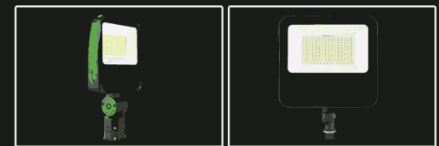
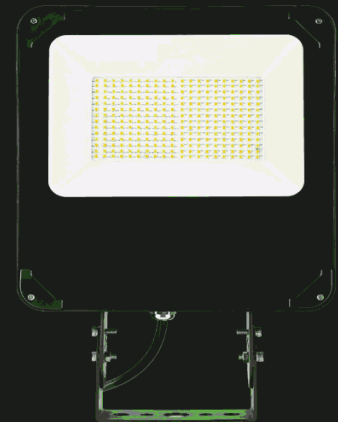
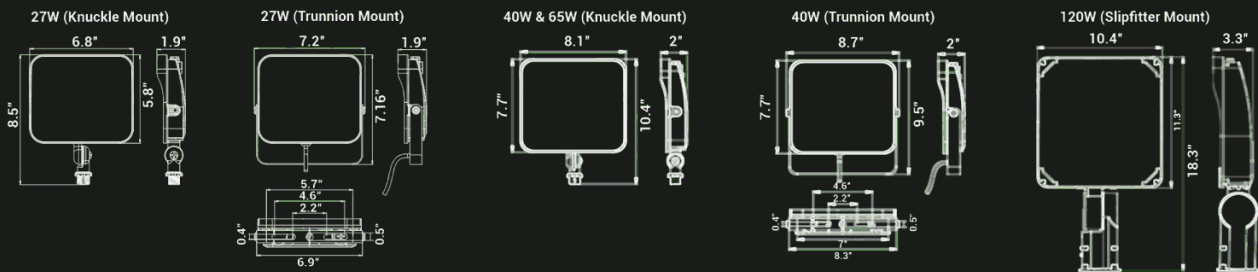

MODEL	COLOR TEMPERATURE	POWER	LUMEN OUTPUT	EFFICACY	INPUT VOLTAGE RANGE	AVAILABILITY
NUR-FL11-27W-CCT-TM	CCT ADJUSTABLE	27W	3500LM, 3800LM, 3600LM	130 lm/W, 141 lm/W, 133 lm/W	120-277VAC	IN STOCK
NUR-FL11-27W-CCT-KM						
NUR-FL11-40W-CCT-TM		40W	5700LM, 6000LM, 5800LM	143 lm/W, 150 lm/W, 145 lm/W		
NUR-FL11-40W-CCT-KM						
NUR-FL11-65W-CCT-KM		65W	9200LM, 9700LM, 9400LM	142 lm/W, 149 lm/W, 145 lm/W		
NUR-FL11-120W-CCT-SF	120W	17500LM, 19000LM, 18000LM	146 lm/W, 158 lm/W, 150 lm/W			



scan to buy

LED SWAN POST LIGHT

DESCRIPTION :

The sleek Post Top luminaire is available as a 70W fixture, is capable of replacing up to 280W HID fixtures with its super bright LED technology. It can be effectively used for outdoor spaces including parking lots and gardens.

FEATURES :

- Die-cast aluminum housing with powder coat finish to resist fading
- Toughened glass lens
- 2-3/8" or 3" post top tenon
- Outdoor use

70
CRI



WET LOCATION

IP65

Outdoor

5 year
warranty

APPLICATIONS :

- Pathways
- Parking lots
- Gardens

DIMENSION :

unit:inch

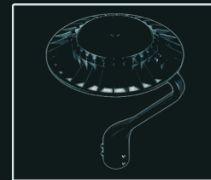
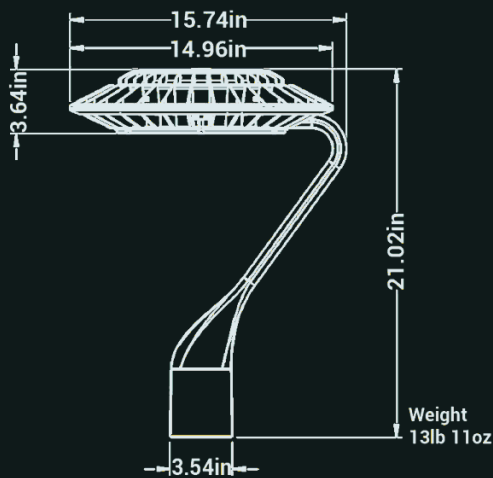

MODEL	COLOR TEMPERATURE	POWER	LUMEN OUTPUT	EFFICACY	REPLACES	INPUT VOLTAGE RANGE	AVAILABILITY
NUR-AL-SWAN-70W-4000K	4000K	70W	9,100 LM	125-135LM/W	250W MH	120-277VAC	IN STOCK



scan to buy

LED POST TOP LIGHT

FEATURES :

- Adjustable CCT (30K/40K/50K)
- Scale shape and Solid material.
- Efficacy higher than 120 LM/W with zero uplight.
- Optional for single and double arm mounting.
- Installation of poles which top diameter limited to 2-3/8" or 3".
- Suitable for installation heights of 8-20 feet.
- Projected over 50,000 hrs life span.



APPLICATIONS :

- Greenbelts
- Walking Pathways
- Building Perimeters requiring a proper light source.

DIMENSION :

unit:inch

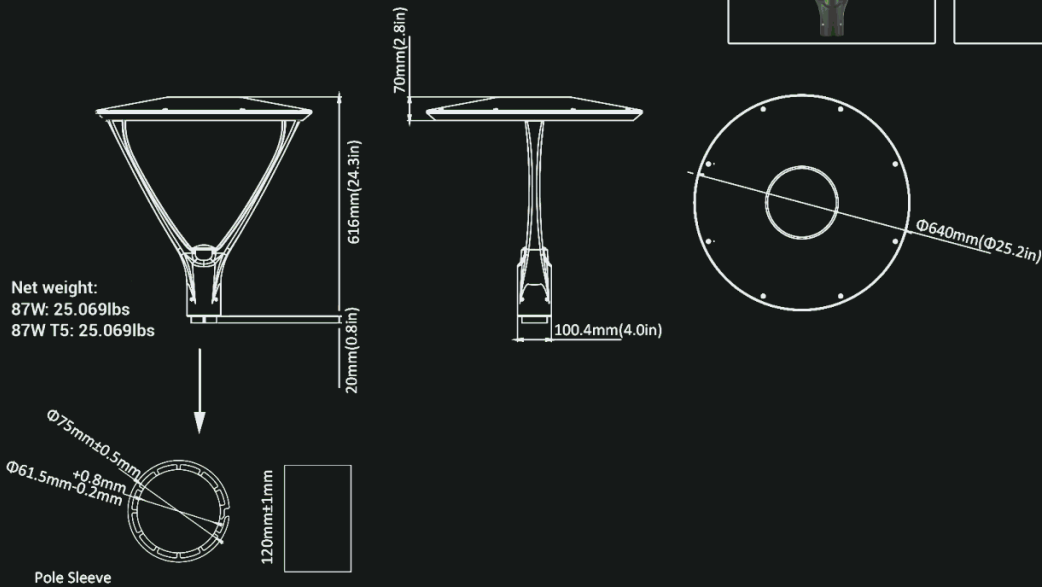

MODEL	FINISH	POWER	COLOR TEMPERATURE	LUMEN OUTPUT	EFFICACY	INPUT VOLTAGE RANGE	AVAILABILITY
NUR-PL01-87W-CCT-WHT	WHITE	87W	CCT (3000K, 4000K 5000K)	11500LM	122 LM/W	120-277VAC	IN STOCK
NUR-PL01-87W-CCT-BNZ	DARK BRONZE			12500 LM			
				12000LM			

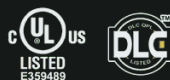

scan to buy

POLES

DESCRIPTION :

Poles are an integral part of commercial lighting installation. LED City now offers poles made of commercial quality steel and aluminum in lengths ranging from 10ft to 30ft. The poles include shaft, base cover and rain proof cover.

FEATURES :

- Material: High strength aluminum tube/Commercial quality steel, weldable grade, hot rolled carbon steel tubing. All welds confirm to AWS D1.1 using E70xx electrodes.
- Height: 10-30 ft
- Finish: Dark Bronze
- Wall thickness gauge: 11
- Maximum EPA rating: 11.5 @ 120mph

APPLICATIONS :

- Parking lots
- Retail centers
- Industrial parks
- Schools and universities
- Public transit and airports
- Office buildings and medical facilities



SQUARE LIGHT POLE

ROUND LIGHT POLE

ACCESSORIES:



RAIN COVER



POLE TOP CAP

MODEL	MATERIAL	SHAPE	POLE DIMENSIONS (MOUNTING HEIGHT X SHAFT SIZE)	MAXIMUM EPA RATING
NUR-WSD-RAL15FT4-125-D (with covers)	ALUMINUM	ROUND	15ft x 4in	7.4 @ 120mph
NUR-WSD-RAL20FT4-125-D (with covers)			20ft x 4in	4.6 @ 120mph
NUR-WSD-RAL25FT4-125-D (with covers)			25ft x 4in	4.2 @ 120mph
NUR-WSD-R10FT3-11G-D (with covers)	STEEL		10ft x 3in	11.6 @ 120mph
NUR-WSD-R15FT4-11G-D (with covers)			15ft x 4in	7.4 @ 120mph
NUR-WSD-R20FT4-11G-D (with covers)			20ft x 4in	4.6 @ 120mph
NUR-WSD-R25FT4-11G-D (with covers)			25ft x 4in	4.2 @ 120mph
NUR-WSD-R30FT5-11G-D (with covers)			30ft x 5in	3.2 @ 120mph
NUR-WSD-SAL20FT4-125-D-T (with covers)	ALUMINUM		SQUARE	20ft x 4in
NUR-WSD-SAL25FT5-125-D-T (with covers)		25ft x 5in		1.6 @ 120mph
NUR-WSD-10FT4-11G-D-T (with covers)	STEEL	10ft x 4in		11.5 @ 120mph
NUR-WSD-15FT4-11G-D-T (with covers)		15ft x 4in		6.2 @ 120mph
NUR-WSD-20FT4-11G-D-T (with covers)		20ft x 4in		3.1 @ 120mph
NUR-WSD-25FT4-11G-D-T (with covers)		25ft x 4in		3.0 @ 120mph
NUR-WSD-30FT4-11G-D-T (with covers)		30ft x 5in		3.25 @ 120mph



scan to buy

POLES PRE-INSTALLATION KIT

ANCHOR BOLTS

SKU: NUR-WSD-BMS-D
Availability: In stock



SCREW POSITIONING PLATE

SKU: NUR-WSD-SPP-D
Availability: In stock

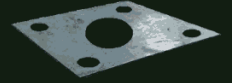

INSTALLATION KITS FOR FLOOD/AREA LIGHTS FOR POLES

SLIPFITTER MOUNT

SKU: NUR-MNT-SF
Finish: Dark Bronze
Availability: In stock
Two 1/2" hex head screws included with mount



ROUND POLE MOUNT

SKU: NUR-MNT-PM-BNZ(ARM)
Finish: Dark Bronze
Availability: In stock
Two 5/16" hex bolts and Two 1/2" hex head screws included with mount



SQUARE POLE MOUNT

SKU: NUR-MNT-SQA01DA-A
Finish: Dark Bronze
Availability: Special Order
Two 5/16" hex bolts and Two 1/2" hex head screws included with mount



TRUNNION MOUNT

SKU: NUR-MNT-TM/TR-BNZ
Finish: Dark Bronze
Availability: In stock

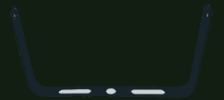

YOKE MOUNT

SKU: NUR-MNT-TM/YK-BNZ
Finish: Dark Bronze
Availability: In stock



WALL MOUNT

SKU: NUR-MNT-WM-BNZ
Finish: Dark Bronze
Availability: In stock
Two 5/16" hex bolts included with mount



POLES BRACKET

4" SQUARE POLE MOUNT WITH 2-3/8" O.D. TENON

SKU: NUR-ADP-Pole-S-4"
Finish: Dark Bronze
Availability: In stock
Four 5/16" hex bolts included with mount



4" ROUND POLE MOUNT WITH 2-3/8" O.D. TENON

SKU: NUR-ADP-4SQR-SP-D
Finish: Dark Bronze
Availability: In stock
Three 3/8" hex bolts included with mount



5" SQUARE POLE MOUNT WITH 2-3/8" O.D. TENON

SKU: NUR-ADP-Pole-S-5"
Finish: Dark Bronze
Availability: In stock
Four 5/16" hex bolts included with mount



5" ROUND POLE MOUNT WITH 2-3/8" O.D. TENON

SKU: NUR-ADP-5SQR-SP-D
Finish: Dark Bronze
Availability: In stock
Three 3/8" hex bolts included with mount



TENON AND YOKE ADAPTOR

SKU: NUR-ADP-WALL-FML
Finish: Dark Bronze
Availability: Special Order



ADJUSTABLE POLE MOUNT

SKU: NUR-MNT08-ADJ-ARM-BNZ
Finish: Dark Bronze
Availability: In stock



WALL BRACKET

90° 2-3/8" O.D. TENON

SKU: NUR-ADP-WALL-90D
 Finish: Dark Bronze
 Availability: Special Order
 3/8" bolts are required for mounting



MID POLE TENON

2-3/8" O.D. HORIZONTAL TENON MID-POLE BRACKET

SKU: NUR-ADP-SQ-SP-D
 Finish: Dark Bronze
 Availability: Special Order

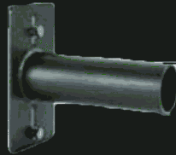

DOUBLE 90° HORIZONTAL TENON ADAPTOR

SKU: NUR-MNT-R60-SP2-180-D
 Finish: Dark Bronze
 Availability: Special Order
 Two fixtures can be mounted and adjusted horizontally



TRIPLE 120° HORIZONTAL TENON ADAPTOR

SKU: NUR-MNT-R60-SP3-120-D
 Finish: Dark Bronze
 Availability: Special Order
 Three fixtures can be mounted and adjusted horizontally



BULLHORNS

180° DOUBLE BULLHORN

SKU: NUR-RB2.5D180-D
 Finish: Dark Bronze
 Availability: Special Order
 Two fixtures can be mounted and adjusted horizontally



90° QUAD BULLHORN

SKU: NUR-RB2.5QD90-D
 Finish: Dark Bronze
 Availability: Special Order
 Four fixtures can be mounted and adjusted horizontally



ROUND EXTERNAL MOUNT HORIZONTAL TENON

DOUBLE 90° HORIZONTAL TENON ADAPTOR

SKU: NUR-MNT-R60-SP2-90-D
 Finish: Dark Bronze
 Availability: Special Order
 Two fixtures can be mounted and adjusted horizontally



TRIPLE 90° HORIZONTAL TENON ADAPTOR

SKU: NUR-MNT-R60-SP3-90-D
 Finish: Dark Bronze
 Availability: Special Order
 Three fixtures can be mounted and adjusted horizontally



QUAD 90° HORIZONTAL TENON ADAPTOR

SKU: NUR-MNT-R60-SP4-90-D
 Finish: Dark Bronze
 Availability: Special Order
 Four fixtures can be mounted and adjusted horizontally



180° TRIPLE BULLHORN

SKU: NUR-RB2.5TR180-D
 Finish: Dark Bronze
 Availability: Special Order
 Three fixtures can be mounted and adjusted horizontally



LOW PROFILE BULLHORN WITH 2 TENONS

SKU: NUR-VTS4R-2T-D
 Finish: Dark Bronze
 Availability: Special Order
 Two fixtures can be mounted and adjusted horizontally



EXIT/EMERGENCY

An exit sign is a pictogram in a public facility (such as a building, aircraft, or boat) denoting the location of the closest emergency exit in case of fire or other emergency that requires evacuation. Most relevant codes (fire, building, health, or safety) require exit signs to be permanently lit.



CONTENT:

- Exit Sign
- Exit Sign With Emergency Light Head
- LED Emergency Light Head

PAGE NO#

67
68
69

Exit Sign



Round Emergency Light Head

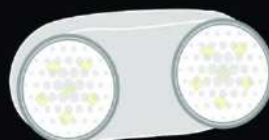

Square Emergency Light Head



EXIT SIGN

DESCRIPTION :

NUR Exit Sign can be used to illuminate exit routes in all commercial and industrial environments. Exit Signs need to be illuminated at all times, even when the building is not occupied. This highly efficient LED Exit Sign provides a cost effective and energy efficient solution for such requirements.

FEATURES :

- Injection molded thermoplastic ABS housing
- Fire resistant
- 1.2V Nickel Cadmium battery
- Charging time: 24 hours
- Discharging time: 90 minutes
- Operating temperature is 32°F to 104°F
- Single sided and Double sided inserts included

APPLICATIONS :

- Commercial, industrial, educational, religious and medical buildings
- All exit routes in a building which includes hallways, stairwells and corridors

DIMENSION :

unit: inch

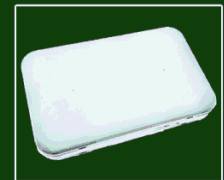

MODEL	COLOR	INPUT VOLTAGE RANGE	DISCHARGE TIME	AVAILABILITY
NUR-EXIT-CR7037-G	GREEN	120-277VAC	90 MINUTES	IN STOCK
NUR-EXIT-CR7037-R	RED			



scan to buy

EXIT SIGN WITH EMERGENCY LIGHT HEAD

DESCRIPTION :

Exit signs are designed to be absolutely unmistakable and understandable to anyone. In the past, this generally meant exit signs that show the word "EXIT" or the equivalent in the local language, but increasingly exit signs around the world are in pictogram form, with or without supplementary text.

FEATURES :

- Injection molded thermoplastic housing
- Easy installation
- Wall or ceiling mounting
- Double/Single face configuration
- Input Voltage: 120-277V AC
- Energy efficient
- Exit Light single/double face with Red letters
- Power: 2.4W
- 3.6V nickel cadmium battery
- Test switch and charge indicator light
- Backup time: ≥90minutes



DIMENSION :

unit: inch

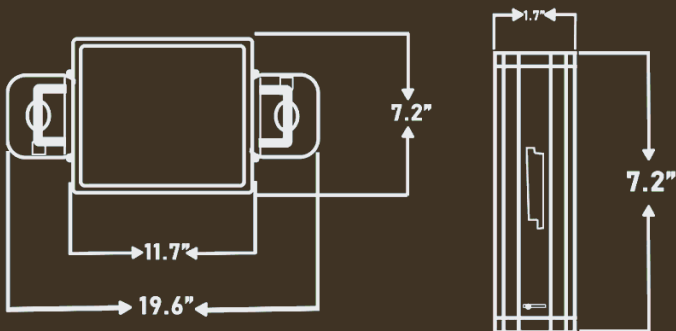

MODEL	COLOR	TYPE
NUR-EXIT-COM-RED-S	RED	SQUARE
NUR-EXIT-COM-RED-R		ROUND

Square



scan to buy



Round



scan to buy

LED EMERGENCY LIGHT HEAD

DESCRIPTION :

An emergency light is a battery-backed lighting device that switches on automatically when a building experiences a power outage. Emergency lights are standard in new commercial and high occupancy residential buildings, such as college dormitories, apartments, and hotels. Most building codes require that they be installed in older buildings

FEATURES :

- Injection-moulded thermoplastic ABS housing
- Easy installation
- Battery back-up for 90 minutes
- Wall or ceiling mounting
- 2 lamp heads, each of 1.2W
- Input Voltage: 120-277V AC
- 3.6V nickel cadmium battery
- LED Lamp Round Head
- Backup time: 90 mins.

5 year warranty

DIMENSION :

unit: inch

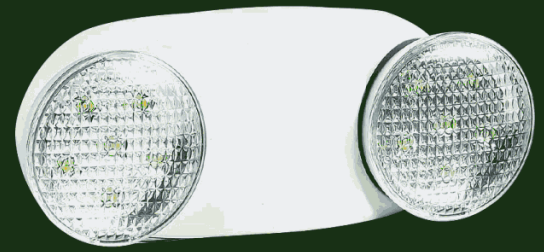
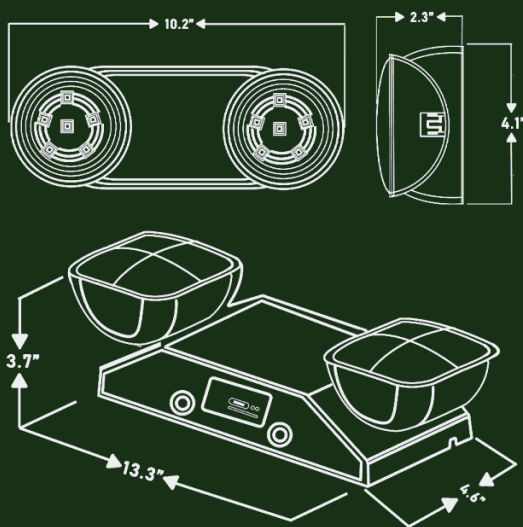

MODEL	BACKUP TIME	TYPE
NUR-EM-LED-90-S	90 MINUTES	SQUARE
NUR-EM-LED-90-R		ROUND

Square



scan to buy



Round



scan to buy

L.E.D. CITY

SIGNS & LIGHTS

**2415 SOUTHWELL ROAD
DALLAS TX 75229**

**972 488 2489
INFO@LEDCITYUSA.COM**