

LED PARKING LOT AREA LIGHT - CCT

DESCRIPTION:

Our LED Parking Lot Area Light is CCT selectable (3000K, 4000K, 5000K) and wattage adjustable (100%, 80%, 60%, 40%). Using a maximum output of 100W, 250W, or 400W, these lights can replace an equivalent 1000W halogen bulb. Adjust the lumen output from 6,400LM to 61,000LM depending on specification requirements. Tested at an LED lifespan of 100,000 hours (LM-80, LM79).



TECHNICAL FEATURES:

- 3CCT Selectable: 3000K, 4000K, 5000K
- Lumen Range: 6,400 to 61,000 Lumens, replaces up to 1000W Metal Halide
- Power Adjustable: 100%, 80%, 60%, 40%
- Operating Temperature: -40° F to 113° F
- Input Voltage: Universal 120-277 VAC
- Surge Protection: 10KA (@ 120-277V)
- Dimming: 0-10V dimmable driver (10% to 100%)
- THD: ≤20% (Total Harmonic Distortion)
- Power Factor: ≥90%
- LED Lifespan: 100,000 hours (LM-80, LM-79)
- Heat Dissipation: Constructed from single-piece die-cast aluminum with an integrated heat sink design for optimal heat dissipation
- 3G Vibration Rating: For mounting heights between 26-50' in various area lighting applications
- UL Wet Location Listed: Sealed housing design offers protection against moisture and environmental contaminants, ensuring durability and longevity

STRUCTURAL DESIGN:

Housing
The one-piece die-cast housing with corrosion-resistant coating protection and the modular design extend the life of the luminaire while making it easy to maintain.

Photometry
Optional Type II, Type III, Type IV and Type V Photometry as per applications.

Photocell
Dusk to dawn controls can be utilized via optional NEMA twist-lock photocell.

CCT & POWER Adjustable
Offer four selectable lumen output (40%, 60%, 80%, 100%), and three selectable CCTs (30K/40K/50K).

Occupancy Sensor
Optional occupancy sensor allows for security and energy saving.

Mounting
Optional for Adjustable square mount, Slipfitter mount, Wall mount, Yoke mount. All mounting brackets are simple to operate, which can realize single operation and reduce labor costs.

POWER CCT

LV1	5KK
LV2	4KK
LV3	3KK
LV4	

LIGHTING APPLICATIONS:

- Parking Lots
- Courtyards
- Driveways
- Buildings
- Billboards
- Street Lights

DIMENSIONS:

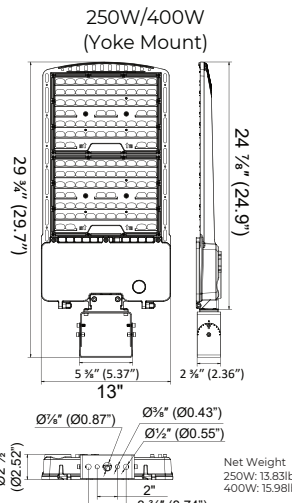
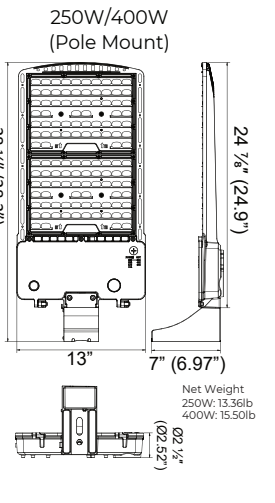
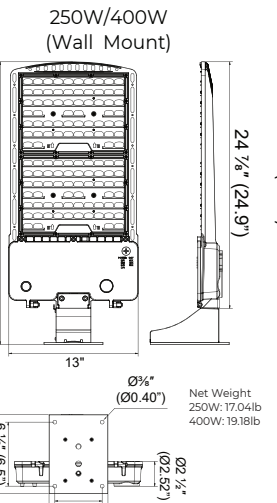
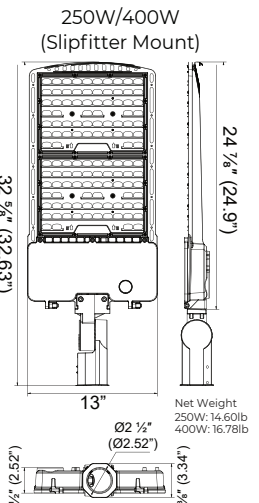
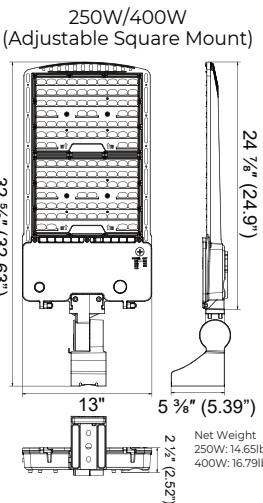
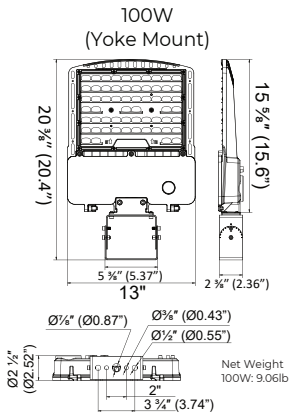
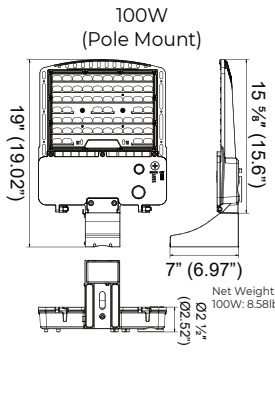
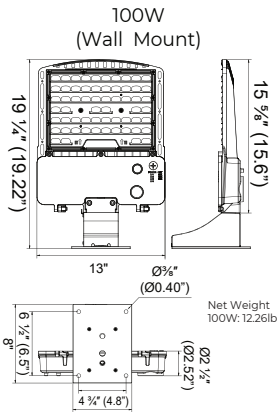
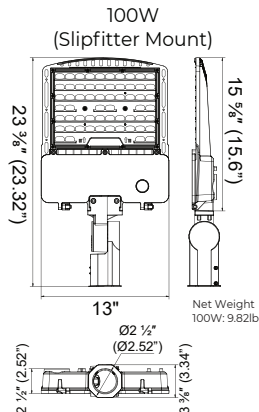
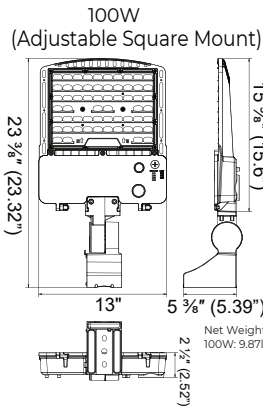

MOUNTING:



Arm Mount

SKU: NUR-MNT05-PM(ARM)-BNZ



Slipfitter Mount

SKU: NUR-MNT05-SF-BNZ



Wall Mount

SKU: NUR-MNT05-WM-BNZ



Yoke Mount

SKU: NUR-MNT05-YK-BNZ

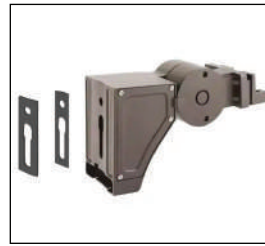

Adjustable Pole Mount

SKU: NUR-MNT08-ADJ-ARM-BNZ

MOUNTING DIMENSIONS FOR ARM MOUNT (SOLD SEPARATELY):

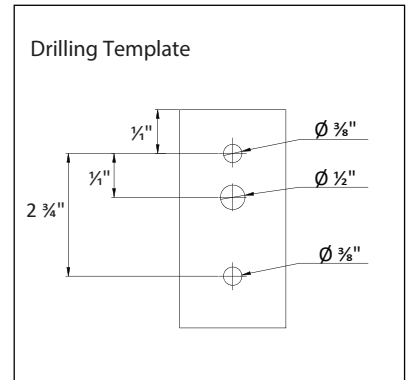
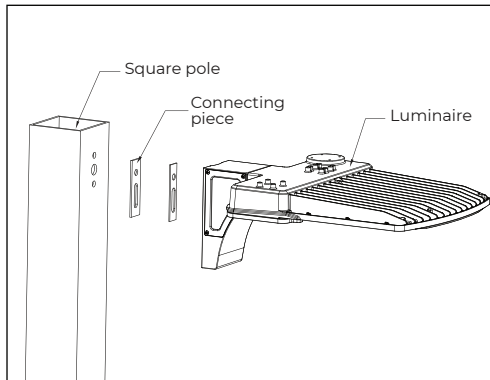
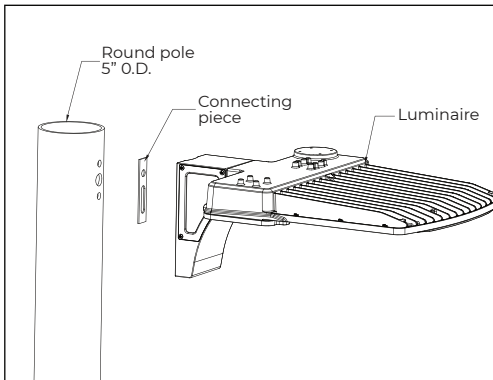

EFFECTIVE PROJECTED AREA:

Item							
	1	2 @90°	2 @120°	2@180°	3 @90°	3 @120°	4 @90°
100W	0.3632	0.6849	0.8861	0.7264	1.0481	1.2078	1.0481
250W/400W	0.4758	0.8091	1.059	0.9516	1.2849	1.3923	1.2849

WATTAGE AND LUMENS ADJUSTABLE:

100W									
SETTING	SYSTEM WATTS	DIST.TYPE	CRI	3000K		4000K		5000K	
				LUMENS	LPW	LUMENS	LPW	LUMENS	LPW
100%	100W	2	70	14500lm	145 lm/W	15800lm	158 lm/W	15000lm	150 lm/W
		3	70	14500lm	145 lm/W	15800lm	158 lm/W	15000lm	150 lm/W
		4	70	14500lm	145 lm/W	15800lm	158 lm/W	15000lm	150 lm/W
		5	70	15100lm	151 lm/W	16000lm	160 lm/W	15600lm	156 lm/W
80%	80W	2	70	12000lm	150 lm/W	13000lm	163 lm/W	12500lm	156 lm/W
		3	70	12000lm	150 lm/W	13000lm	163 lm/W	12500lm	156 lm/W
		4	70	12000lm	150 lm/W	13000lm	163 lm/W	12500lm	156 lm/W
		5	70	12500lm	156 lm/W	13300lm	166 lm/W	12800lm	160 lm/W
60%	60W	2	70	9300lm	155 lm/W	10000lm	167 lm/W	9600lm	160 lm/W
		3	70	9300lm	155 lm/W	10000lm	167 lm/W	9600lm	160 lm/W
		4	70	9300lm	155 lm/W	10000lm	167 lm/W	9600lm	160 lm/W
		5	70	9600lm	160 lm/W	10200lm	170 lm/W	9850lm	164 lm/W
40%	40W	2	70	6400lm	160 lm/W	6800lm	170 lm/W	6560lm	164 lm/W
		3	70	6400lm	160 lm/W	6800lm	170 lm/W	6560lm	164 lm/W
		4	70	6400lm	160 lm/W	6800lm	170 lm/W	6560lm	164 lm/W
		5	70	6560lm	164 lm/W	7000lm	175 lm/W	6700lm	168 lm/W

250W									
SETTING	SYSTEM WATTS	DIST.TYPE	CRI	3000K		4000K		5000K	
				LUMENS	LPW	LUMENS	LPW	LUMENS	LPW
100%	250W	2	70	33500lm	134 lm/W	37000lm	148 lm/W	34500lm	138 lm/W
		3	70	33500lm	134 lm/W	37000lm	148 lm/W	34500lm	138 lm/W
		4	70	33500lm	134 lm/W	37000lm	148 lm/W	34500lm	138 lm/W
		5	70	34500lm	138lm/W	38000lm	152lm/W	35500lm	142lm/W
80%	200W	2	70	27500lm	138 lm/W	30400lm	152 lm/W	28400lm	142 lm/W
		3	70	27500lm	138 lm/W	30400lm	152 lm/W	28400lm	142 lm/W
		4	70	27500lm	138 lm/W	30400lm	152 lm/W	28400lm	142 lm/W
		5	70	28000lm	140 lm/W	31000lm	155 lm/W	28800lm	144 lm/W
60%	150W	2	70	21300lm	142 lm/W	23200lm	155 lm/W	21800lm	145 lm/W
		3	70	21300lm	142 lm/W	23200lm	155 lm/W	21800lm	145 lm/W
		4	70	21300lm	142 lm/W	23200lm	155 lm/W	21800lm	145 lm/W
		5	70	21800lm	145 lm/W	23800lm	159 lm/W	22500lm	150 lm/W
40%	100W	2	70	14500lm	145 lm/W	16000lm	160 lm/W	14800lm	148 lm/W
		3	70	14500lm	145 lm/W	16000lm	160 lm/W	14800lm	148 lm/W
		4	70	14500lm	145 lm/W	16000lm	160 lm/W	14800lm	148 lm/W
		5	70	15000lm	150 lm/W	16500lm	165 lm/W	15500lm	155 lm/W

400W							
SETTING	SYSTEM WATTS	DIST.TYPE	CRI	4000K		5000K	
				LUMENS	LPW	LUMENS	LPW
100%	400W	2	70	60500lm	151 lm/W	60000lm	150 lm/W
		3	70	60500lm	151 lm/W	60000lm	150 lm/W
		4	70	60500lm	151 lm/W	60000lm	150 lm/W
		5	70	61000lm	153 lm/W	60800lm	152 lm/W
80%	360W	2	70	56000lm	156 lm/W	55000lm	153 lm/W
		3	70	56000lm	156 lm/W	55000lm	153 lm/W
		4	70	56000lm	156 lm/W	55000lm	153 lm/W
		5	70	56500lm	157 lm/W	55500lm	154 lm/W
60%	320W	2	70	51000lm	159 lm/W	50000lm	156 lm/W
		3	70	51000lm	159 lm/W	50000lm	156 lm/W
		4	70	51000lm	159 lm/W	50000lm	156 lm/W
		5	70	51500lm	161 lm/W	50500lm	159 lm/W
40%	300W	2	70	47000lm	162 lm/W	46000lm	159 lm/W
		3	70	47000lm	162 lm/W	46000lm	159 lm/W
		4	70	47000lm	162 lm/W	46000lm	159 lm/W
		5	70	47500lm	164 lm/W	46500lm	160 lm/W

PHOTOMETRICS:

Type 2 optics are ideal for applications where there is a need to space luminaires farther apart along a road or pathway. The light distribution pattern is optimized for elongated areas, allowing for greater pole spacing without sacrificing lighting quality.

Type 3 optics produce an asymmetrical pattern that directs the majority of the light forward and equally on both sides of the luminaire. In a back-to-back configuration, it creates a rectangular pattern, extending pole spacings.

Type 4 optics are suitable for applications where light is primarily required forward with minimal backlight. Typical installations include perimeter poles.

Type 5 optics produce a symmetrical square distribution pattern that distributes light equally on all sides of the luminaire. Type 5 luminaires are universal for most area lighting applications.

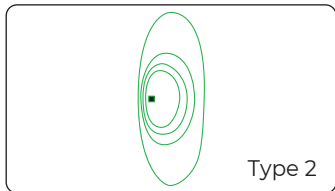

Type 2
Special Order

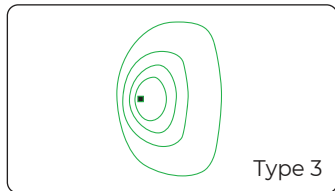

Type 3
Special Order

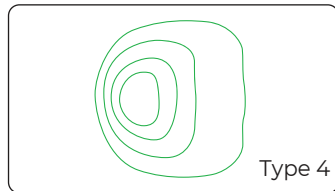

Type 4
Special Order

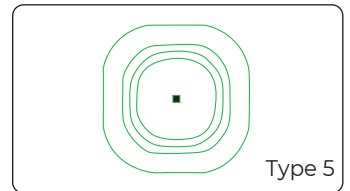

Type 5
In Stock

ORDERING GUIDE:

SKU: NUR-FL08-100W-CCT			
Item	Flood Light	Wattage	Color Temperature
NUR	FL08	100W 250W 400W	CCT (3000K) (4000K) (5000K)