

CCT 4 ZONE TOUCH PANEL WALL REMOTE INSTALL GUIDE

1. Features

We adopt a high precision capacitive touch screen IC. Touch screen is very stable; 2.4GHz high RF wireless control with long distance controlling, low power consumption and high speed transmitting rate.

This product has T series and B series, and the difference is the method of power supplying. Both series have 4 kinds: T1/B1 4-zone dimmable panel remote; T2/B2 CCT 4-zone panel remote; T3/B3 4-zone RGB/RGBW panel remote; T4/B4 4-zone RGB+CCT panel remote. This product widely work on our smart LED Lighting, LED controller and smart panel controller, etc.

2. Parameters

B Series: Powered by 3V(2*AAA Battery)

Working Voltage: 3V(2*AAA Battery)

Standby Power Consumption: 20uA

Transmitting Power: 6dBm

Transmission Frequency: 2.4GHz

Working Temp.: -10~40°C

Control Distance: 98.4 ft

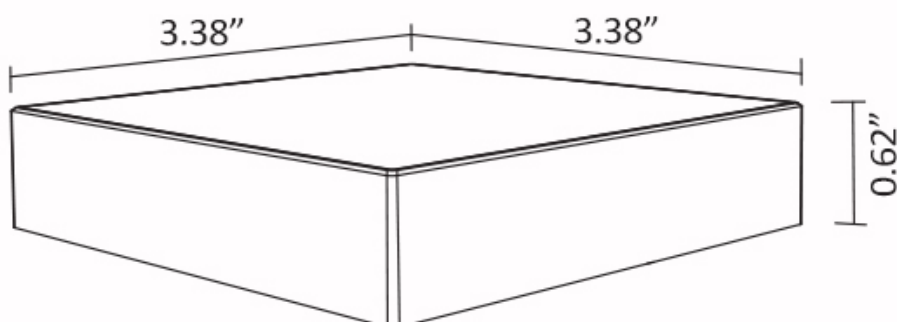

B2 & T2 4-Zone Panel Remote (Color Temp.)

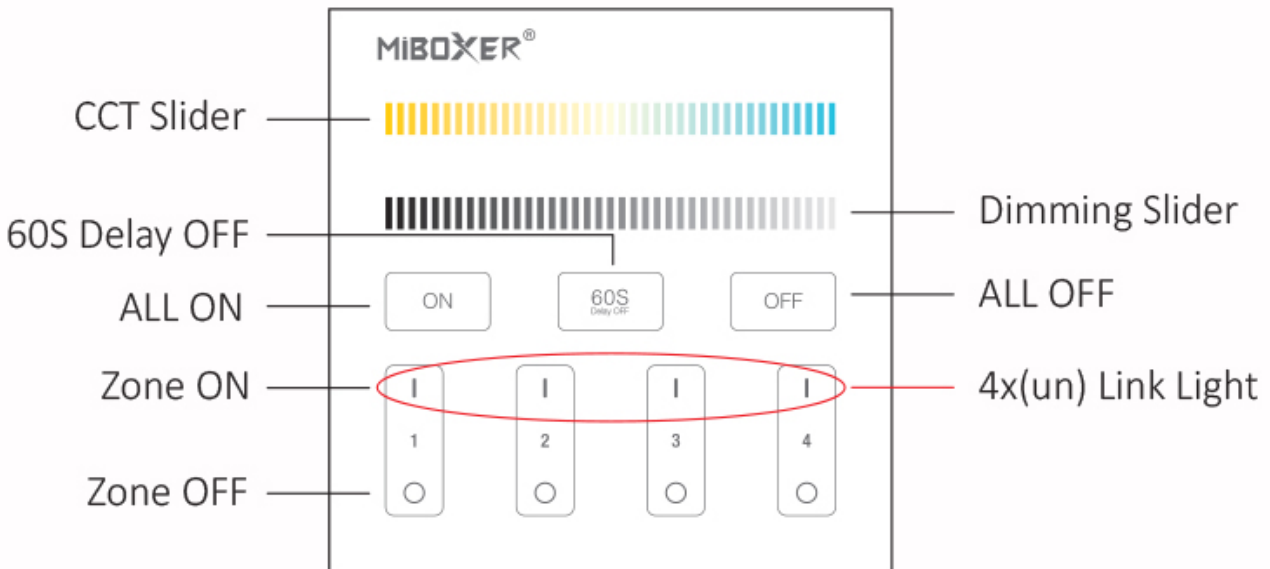

Touch the slider to change color temperature.

Touch dimming slider to change the brightness from 1~100%.

Touch master ON, turn on all linked lights.
Long press 5 seconds to turn ON the indicating sound.

When the light is ON, press "60S Delay OFF", the light will be OFF Automatically after 60 seconds.

Touch master OFF, turn off all linked lights.
Long press 5 seconds to turn OFF the indicating sound.

Touch Zone ON, turn on zone-linked lights.

Touch Zone OFF, turn off zone-linked lights.

3. Link / Unlink (B1-B4 & T1- T4 & B1-B/B3-B/B4-B)

Linking Instructions

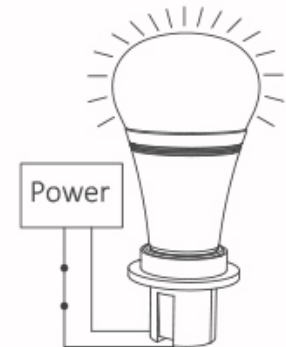
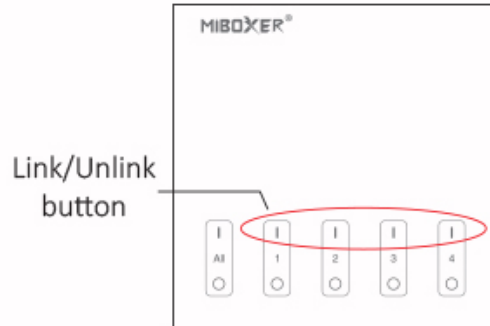
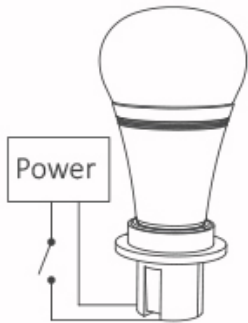

- 1 Switch off the light, after 10 seconds switch on again.
- 2 When the light on, short press any zone of "1" 3 times within 3 seconds.
- 3 The light blink 3 times slowly means the linking is done successfully.

If the light not blink slowly, the linking failed, pls switch off the light again, and follow the above steps again.

Unlinking Instructions

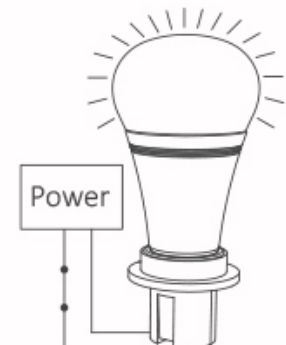
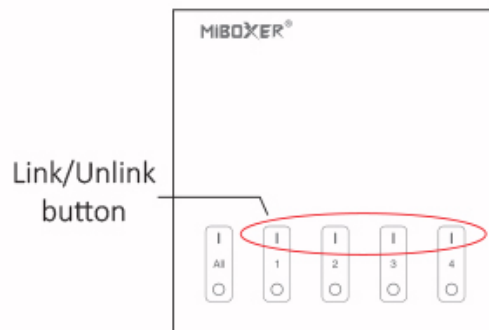
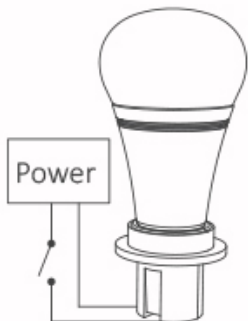

- 1 Switch off the light, after 10 seconds switch on again.
- 2 When the light on, short press "1" 5 times within 3 seconds.
- 3 The light blinking 10 times quickly, means the unlinking successfully.

Unlinking must be the same zone with the Linking

If the light not blink quickly, the unlink failed, pls switch off the light again, and follow the above steps to unlink again.

3. Link / Unlink (B0)

Linking Instructions

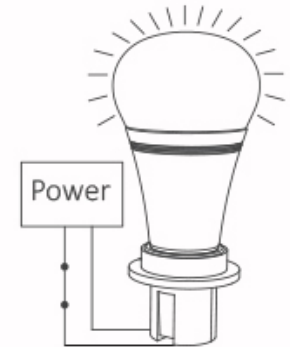
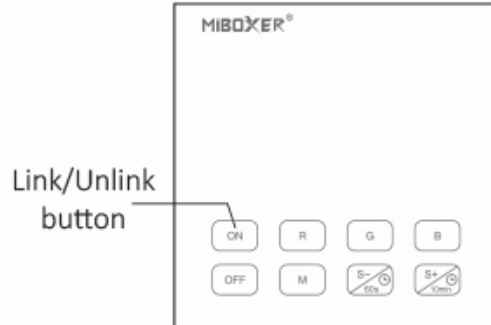
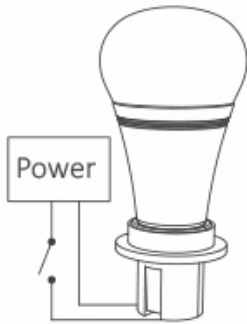

- 1** Switch off the light, after 10 seconds switch on again.
- 2** When the light on, short press "ON" 3 times within 3 seconds.
- 3** The light blink 3 times slowly means the linking is done successfully.



If the light not blink slowly, the linking failed, pls switch off the light again, and follow the above steps again.

Unlinking Instructions

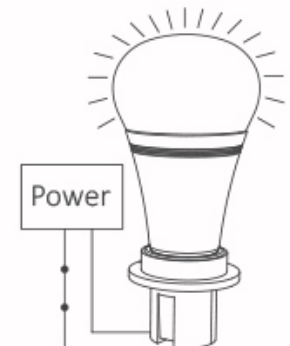
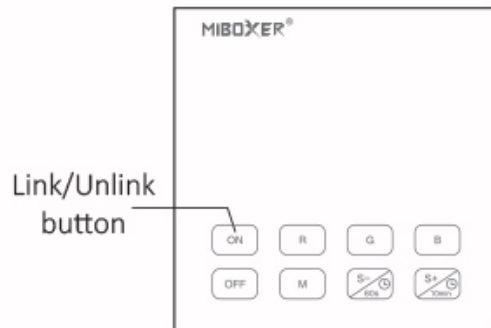
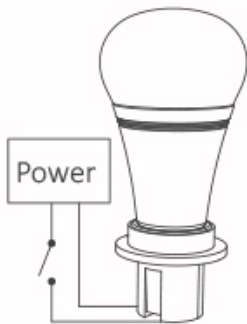

- 1** Switch off the light, after 10 seconds switch on again.
- 2** When the light on, short press "ON" 5 times within 3 seconds.
- 3** The light blinking 10 times quickly, means the unlinking successfully.



If the light not blink quickly, the unlink failed, pls switch off the light again, and follow the above steps to unlink again.

4. Installation

B series Installation

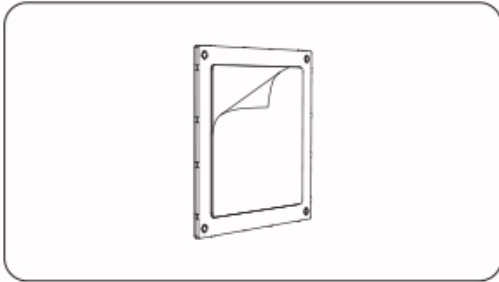

1. Tear out the back tape.

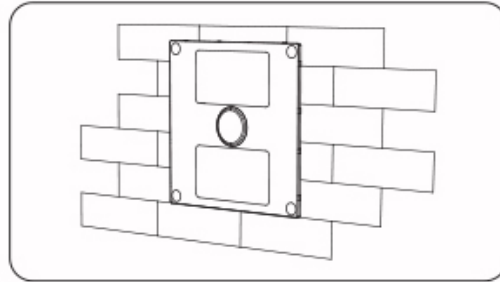

2. Stick the holder on the position where you want.

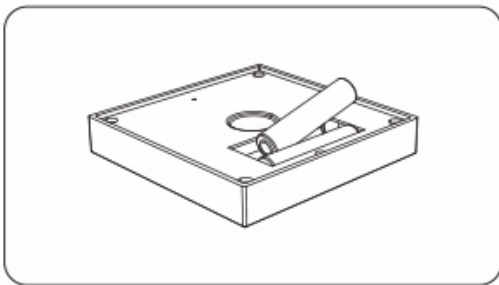

3. Install 2*AAA battery.

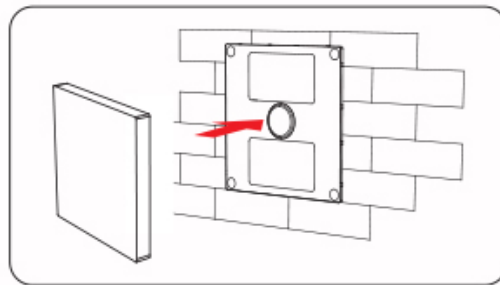

4. Put the rotating switch on the front of holder.

T series Installation/ Dismantlement

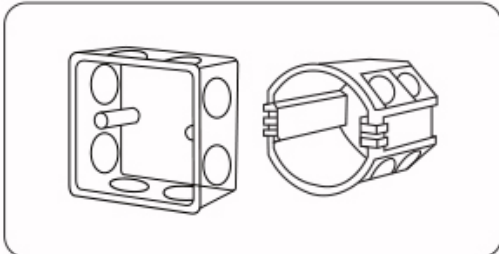

Install the bottom case into the wall;
Above are the standard bottom cases.

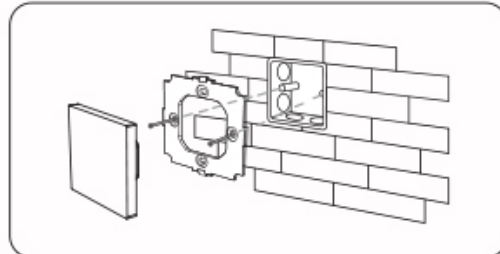

Fix the controller base on the bottom
case with screw.

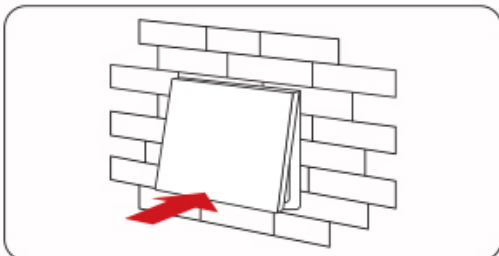

Clicks into the upper side of glass panel on
the controller base, then press the lower
side slightly to make it clicks into the
controller base.

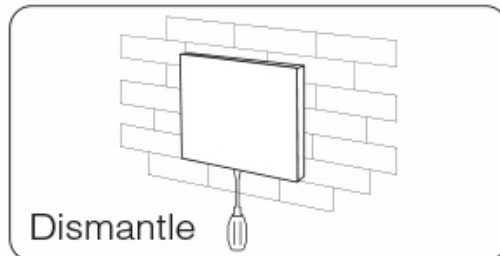

Dismantle

Plug into the below bayonet with a
screwdriver, and upwarp screwdriver,
then you can dismantle the controller.