

STRAIGHT SQUARE STEEL POLES 4" & 5"

Description:

Straight Square Steel poles are built from high strength steel tube and are available side drilled for arm mounted area lighting luminaires or with tenon mounts for flood and post top luminaires.

Specifications:

- Conforms to ASTM-A 500 Grade B: Minimum yield strength of 46,000 PSI.
- **Finish:** Textured architectural bronze powdercoat finish, baked to ensure maximum paint adhesion, hardness and durability.
- **Anchor bolts:** Anchor bolts are not included, sized based on pole data charts for the selected pole size.
- **Hand hole:** Cast iron reinforced hand hole and cover with ground screw.
- **Base cover:** Poles are provided with a two-piece formed steel base cover that is easily assembled and fitted over pole base.
- **Pole length:** Poles are available in standard lengths as shown in the order matrix. Poles can be custom cut to order. Consult factory.

Mounting options:

Standard length poles include 2 $\frac{3}{8}$ " od tenon, side drilled 4@90°, polycarbonate top cover and hole plugs for unused drilling locations.

Cut to order poles can be side drilled for 2@180° or 4@90°, includes polycarbonate top cover and hole plugs for unused drilling locations.

Cut to order poles may also be ordered with 2 $\frac{3}{8}$ " od tenons for use with post top decorative luminaires, flood/area slip fitter fixtures, or any of a wide variety of pole top mounting accessories.

Our standard equipment is to make a top adapter with 2.5 inches. There is no opening on the top of the light pole. If arm installation is needed, the top adapter shall be removed and holes shall be opened on the wall of the light pole. Finally, seal the top with a plastic rain cover.



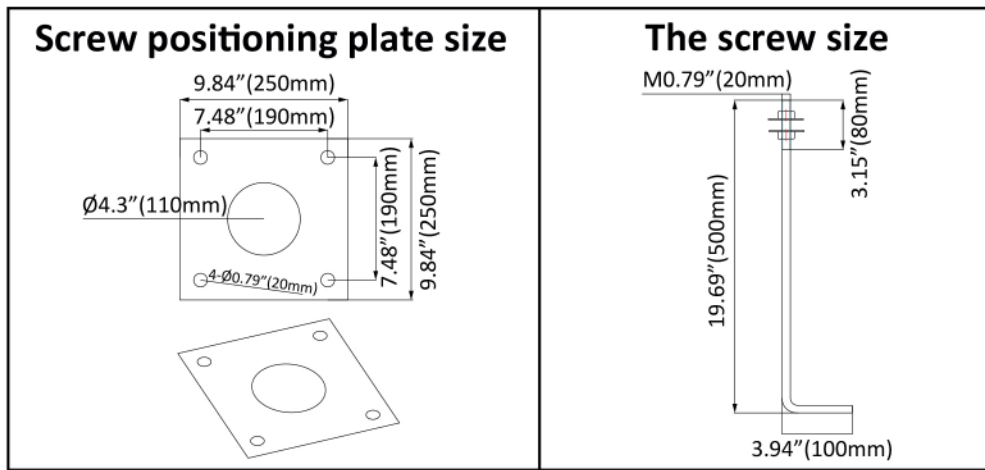
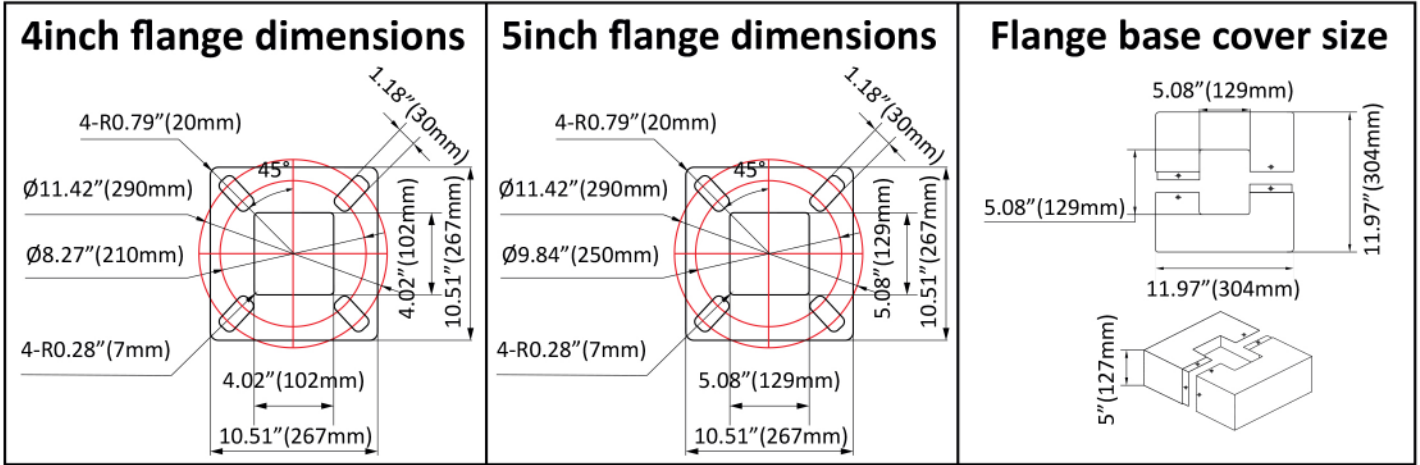

Specifications:

Specification Type	10FT	15FT	20FT	25FT	30FT
NUR-WSD-10FT4-11G-D-T	L= 3.0 (m)	L= 4.6 (m)	L= 6.1 (m)	L= 7.6 (m)	L= 9.1 (m)
NUR-WSD-15FT4-11G-D-T					
NUR-WSD-20FT4-11G-D-T					
NUR-WSD-25FT4-11G-D-T					
NUR-WSD-30FT5-11G-D-T					

Applications:

Typical area lighting applications include:

- Retail centers
- Industrial parks
- Schools and universities
- Public transit and airports
- Office buildings
- Medical facilities.

Ordering guide

Example: NUR-WSD-10FT-4-11G-D-T

Fixture Type	Height	Size	Wall Thickness	Finish	Mounting
<input type="text"/>	<input type="text"/>	<input type="text"/>	<input type="text"/>	<input type="text"/>	<input type="text"/>
NUR-WSD (Square Steel Pole)	10FT (3.0M) 15FT (4.6M) 20FT (6.1M) 25FT (7.6M) 30FT (9.1M)	4 (4x4 in.) 5 (5x5 in.)	11G (11guage)	D (Dark Bronze)	T (2.5 inch adapter)

National Wind Velocity Map

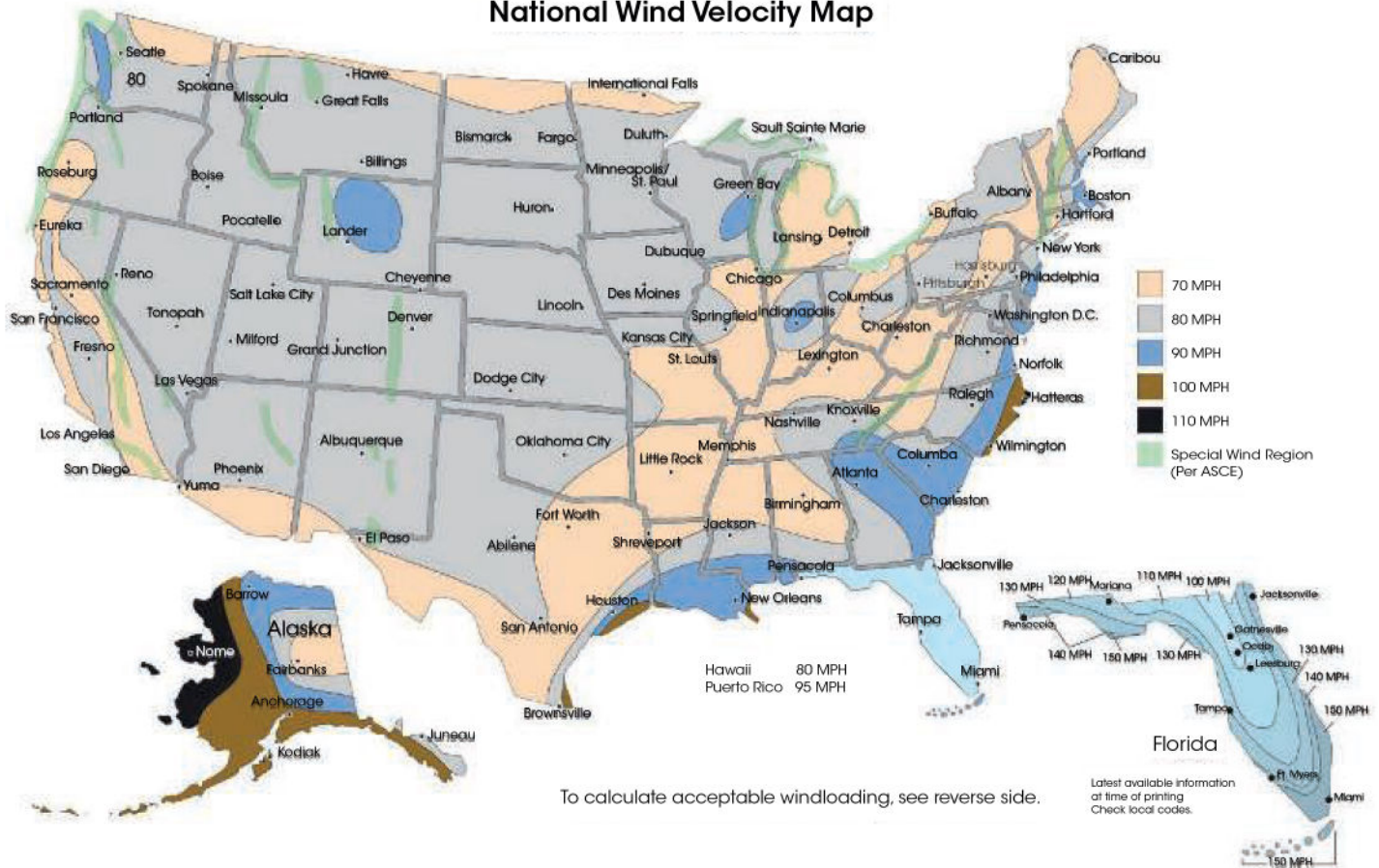

Square external mount horizontal tenon.

- To mount 2/3/4 fixtures on an existing pole



Low profile bullhorn with 3 tenons

NO. NUR-WSD-VTS4R-3T-D

MAX EPA: 1.6

Finish: Dark bronze

USE: The bracket is designed to mount over 2-3/8" O.D. vertical tenon. Two fixtures can be mounted to the round external mount horizontal tenon and adjusted horizontally.



Low profile bullhorn with 2 tenons

NO. NUR-WSD-VTS4R-2T-D

MAX EPA: 1.0

Finish: Dark bronze

USE: The bracket is designed to mount over 2-3/8" O.D. vertical tenon. Two fixtures can be mounted to the round external mount horizontal tenon and adjusted horizontally.



Quad 90° horizontal tenon adaptor

NO. NUR-WSD-QT90-T-D

MAX EPA: 1.8

Finish: Dark bronze

USE: The bracket is designed to mount over 2-3/8" O.D. vertical tenon. Two fixtures can be mounted to the round external mount horizontal tenon and adjusted horizontally.



Triple 120° horizontal tenon adaptor

NO. NUR-WSD-QT120-3T-D

MAX EPA: 1.4

Finish: Dark bronze

USE: The bracket is designed to mount over 2-3/8" O.D. vertical tenon. Two fixtures can be mounted to the round external mount horizontal tenon and adjusted horizontally.

Wall bracker • To mount 2/3/4 fixtures on an existing pole **Mid-pole tenon bracket**
 • Provides wiring access

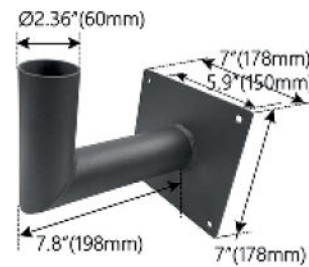

90° Wall mount bracket with 2-3/8" O.D. tenon

NO. NUR-WSD-ADP2.5-90-D

Finish: Dark bronze

MAX EPA: 0.6

USE: The 90° wall mount bracket with 2-3/8" tenon attaches flood and area fixtures to almost any surface: wall, roof, or wood pole. Provides wiring access and a built-in 2-3/8" O.D. tenon to mount a fixture with our adjustable slip-fitter. Suggested 3/8" diameter bolts for mounting. Mounting holes are spaced 3-1/4" apart.

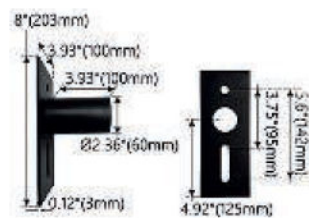

2-3/8" OD horizontal tenon mid-pole bracker

NO. NUR-WSD-ADP2.5-D

Finish: Dark bronze

MAX EPA: 0.3

USE: 2-3/8" OD horizontal tenon mid-pole bracket is designed to mount light fixture that is equipped with an adjustable slip-fitter onto a 2-3/8" OD horizontal tenon.

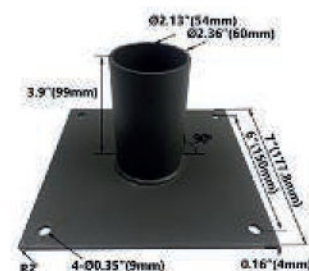

180° Wall mount bracket with 2-3/8" O.D. tenon

NO. NUR-WSD-ADP2.5-180L3.9-D

Finish: Dark bronze

MAX EPA: 0.5

USE: The 180° wall mount bracket with 2-3/8" tenon attaches flood and area fixtures to almost any surface: wall, roof, or wood pole. Provides wiring access and a built-in 2-3/8" O.D. tenon to mount a fixture with our adjustable slip-fitter. Suggested 3/8" diameter bolts for mounting. Mounting holes are spaced 3-1/4" apart.



2-3/8" OD horizontal tenon Arc adaptor

NO. NUR-WSD-ADP2.5-BAR5-D

Finish: Dark bronze

MAX EPA: 0.3

USE: For use with round, non-tapered steel and aluminum poles. 2-3/8" OD horizontal tenon mid-pole bracket is designed to mount light fixture that is equipped with an adjustable slip-fitter onto a 2-3/8" OD horizontal tenon.

Pole bracket • For mounting one fixture on an existing pole

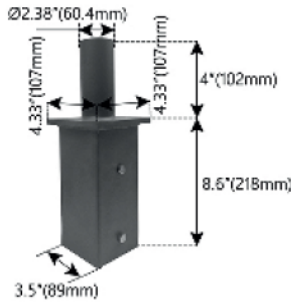

4" Square pole mount with 2-3/8" O.D. tenon

NO. NUR-WSD-VTS4-D

Finish: Dark bronze

MAX EPA: 0.3

USE: For use with square, non-tapered steel and aluminum poles. Furnished with four 5/16" hex head stainless-steel bolts. Vertical tenon measures 2-3/8" O.D., and is made of steel tubing. Fixtures mounted to this bracket can be adjusted both vertically and horizontally.

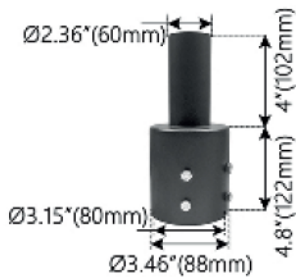

3" Round pole mount with 2-3/8" O.D. tenon

NO. NUR-WSD-VT3-D

Finish: Dark bronze

MAX EPA: 0.3

USE: For use with round, non-tapered steel and aluminum poles. Furnished with four 3/8" hex head stainless-steel bolts. Vertical tenon measures 2-3/8" O.D., and is made of steel tubing. Fixtures mounted to this bracket can be adjusted both vertically and horizontally.

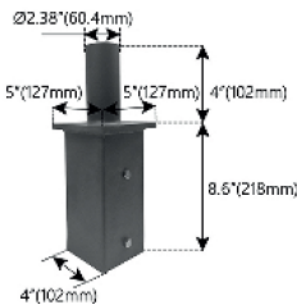

5" Square pole mount with 2-3/8" O.D. tenon

NO. NUR-WSD-VTS5-D

Finish: Dark bronze

MAX EPA: 0.3

USE: For use with square, non-tapered steel and aluminum poles. Furnished with four 5/16" hex head stainless-steel bolts. Vertical tenon measures 2-3/8" O.D., and is made of steel tubing. Fixtures mounted to this bracket can be adjusted both vertically and horizontally.

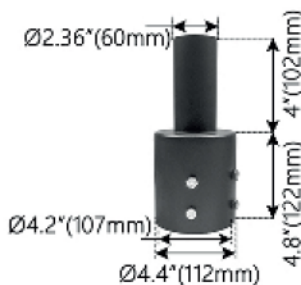

4" Round pole mount with 2-3/8" O.D. tenon

NO. NUR-WSD-VT4-D

Finish: Dark bronze

MAX EPA: 0.3

USE: For use with round, non-tapered steel and aluminum poles. Furnished with four 3/8" hex head stainless-steel bolts. Vertical tenon measures 2-3/8" O.D., and is made of steel tubing. Fixtures mounted to this bracket can be adjusted both vertically and horizontally.



5" Round pole mount with 2-3/8" O.D. tenon

NO. NUR-WSD-VT5-D

Finish: Dark bronze

MAX EPA: 0.3

USE: For use with square, non-tapered steel and aluminum poles. Furnished with four 5/16" hex head stainless-steel bolts. Vertical tenon measures 2-3/8" O.D., and is made of steel tubing. Fixtures mounted to this bracket can be adjusted both vertically and horizontally.



1/2" Round pole mount with 2-3/8" O.D. tenon

NO. NUR-WSD-TADP2.5-1/2-D

Finish: Dark bronze

MAX EPA: 0.3

USE: For use with round, non-tapered steel and aluminum poles. Vertical tenon measures 2-3/8" O.D., and is made of aluminum tubing,

Round external mount horizontal tenon. • To mount 2/3/4 fixtures on an existing pole



Double 90° horizontal tenon adaptor

NO. NUR-WSD-SB2.5TW90-D

Finish: Dark bronze

MAX EPA: 0.6

USE: The bracket is designed to mount over 2-3/8" (60mm) O.D. vertical tenon. Two fixtures can be mounted to the round external mount horizontal tenon and adjusted horizontally.



Triple 120° horizontal tenon adaptor

NO. NUR-WSD-SB2.5TR120-D

Finish: Dark bronze

MAX EPA: 0.7

USE: The bracket is designed to mount over 2-3/8" (60mm) O.D. vertical tenon. Three fixtures can be mounted to the round external mount horizontal tenon and adjusted horizontally.

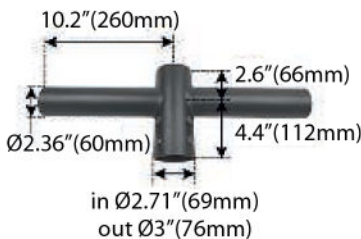

Double 180° horizontal tenon adaptor

NO. NUR-WSD-SB2.5TW180-D

Finish: Dark bronze

MAX EPA: 0.4

USE: The bracket is designed to mount over 2-3/8" (60mm) O.D. vertical tenon. Two fixtures can be mounted to the round external mount horizontal tenon and adjusted horizontally.



Quad 90° horizontal tenon adaptor

NO. NUR-WSD-SB2.5QD90-D

Finish: Dark bronze

MAX EPA: 1.0

USE: The bracket is designed to mount over 2-3/8" (60mm) O.D. vertical tenon. Four fixtures can be mounted to the round external mount horizontal tenon and adjusted horizontally.



Single spoke bracket tenon adaptor

NO. NUR-WSD-SB2.5S90-D

Finish: Dark bronze

MAX EPA: 0.4

USE: The bracket is designed to mount over 2-3/8" (60mm) O.D. vertical tenon. One fixture can be mounted to the round external mount horizontal tenon and adjusted horizontally.



Double 180° horizontal tenon adaptor

NO. NUR-WSD-RB2.5D180-D

Finish: Dark bronze

MAX EPA: 0.9

USE: The bracket is designed to mount over 2-3/8" (60mm) O.D. vertical tenon. Two fixtures can be mounted to the round external mount horizontal tenon and adjusted horizontally.

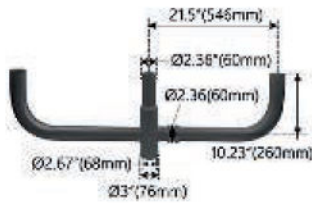

Triple 180° horizontal tenon adaptor

NO. NUR-WSD-RB2.5TR180-D

Finish: Dark bronze

MAX EPA: 1.4

USE: The bracket is designed to mount over 2-3/8" (60mm) O.D. vertical tenon. Three fixtures can be mounted to the round external mount horizontal tenon and adjusted horizontally.



Quad 90° horizontal tenon adaptor

NO. NUR-WSD-RB2.5QD90-D

Finish: Dark bronze

MAX EPA: 1.5

USE: The bracket is designed to mount over 2-3/8" (60mm) O.D. vertical tenon. Four fixtures can be mounted to the round external mount horizontal tenon and adjusted horizontally.



90° Wall mount bracket with 2-3/8" O.D. tenon

NO. NUR-WSD-ADP2.5-90H-D

Finish: Dark bronze

MAX EPA: 0.7

USE: The 90° wall mount bracket with 2-3/8" tenon attached flood and area fixtures to almost any surface: wall, roof, or wood pole. Provides wiring access and abuilt-in 2-3/8" O.D. tenon to mount a fixture with our adjustable slip-fitter. Suggested 3/8" diameter bolts for mounting. Mounting holes are spaced 3-1/4" apart.



Double 180° horizontal tenon adaptor

NO. NUR-WSD-RB2.5TR180H-D

Finish: Dark bronze

MAX EPA: 1.0

USE: The bracket is designed to mount over 2-3/8" (60mm) O.D. vertical tenon. Four fixtures can be mounted to the round external mount horizontal tenon and adjusted horizontally.



Triple 120° horizontal tenon adaptor

NO. NUR-WSD-SB2.5TR120V-D

Finish: Dark bronze

MAX EPA: 1.5

USE: The bracket is designed to mount over 2-3/8" (60mm) O.D. vertical tenon. Four fixtures can be mounted to the round external mount horizontal tenon and adjusted horizontally.



Double 180° wall mount bracket with 2-3/8" O.D. tenon

NO. NUR-WSD-ADP2.5-180H-D

Finish: Dark bronze

MAX EPA: 1.4

USE: The 180° wall mount bracket with 2-3/8" tenon attached flood and area fixtures to almost any surface: wall, roof, or wood pole. Provides wiring access and abuilt-in 2-3/8" O.D. tenon to mount a fixture with our adjustable slip-fitter. Suggested 3/8" diameter bolts for mounting. Mounting holes are spaced 3-1/4" apart.

Mounting options:

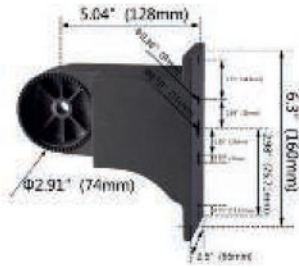

NO. NUR-WSD-NEWSBARM2-D

Finish: Dark bronze

Arm mount 4" and 5" square and round poles. Standard versatile mounting arm is simple to install and can be used with existing poles for retro installations.



NO. NUR-WSD-NEWSBSF2-D

Finish: Dark bronze

Slipfitter mount an optional cast aluminum mast arm adapter secures fixture head to nominal 2"(2-3/8"O.D. pipe size) horizontal steel tenon arm.

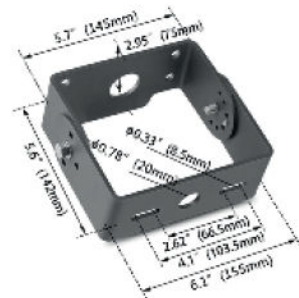

NO. NUR-WSD-SBT-D

Finish: Dark bronze

Easy to install for direct wall mounting with 1/2" conduit wiring.

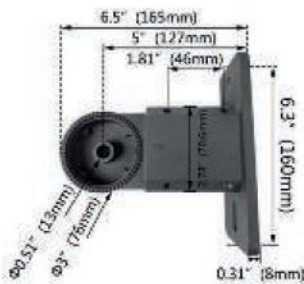

NO. NUR-WSD-SFAFM2-D

Finish: Dark bronze

SFARM2 mount an optional cast aluminum mast arm adapter secures fixture head to nominal 2"(2-3/8"O.D. pipe size) horizontal steel tenon arm.



Base mounting screw

NO. NUR-WSD-BMS-S

Finish: Silver

Before installing the lamp pole, the installation hook should be buried underground and fixed by cement After fixing, the lamp pole should be fixed by locking screw and base installed.

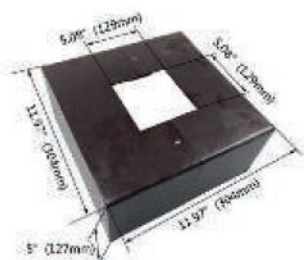

Install base shield

NO. NUR-WSD-IBS5-D

Finish: Dark bronze

The 5" installation of base shield is used to protect the base after fixing the lamp pole, so that the lamp pole base is not damaged, thereby increasing the service life of the lamp pole.

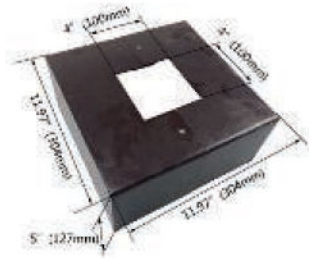

Install base shield

NO. NUR-WSD-IBS4-D

Finish: Dark bronze

The 4" installation of base shield is used to protect the base after fixing the lamp pole, so that the lamp pole base is not damaged, thereby increasing the service life of the lamp pole.



Screw positioning plate

NO. NUR-WSD-SPP-D

Finish: Dark bronze

This is a screw rod positioning plate. After the screw rod of the lamp rod base is fixed underground, the positioning plate is fixed with the screw rod to prevent the screw rod from deviation. Finally, the lamp rod is locked.

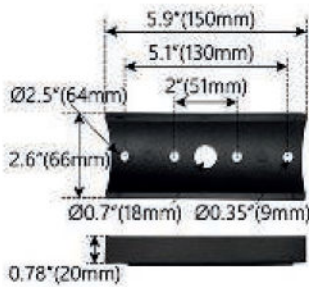

Aqm square tube turn tube tenon adaptor

NO. NUR-WSD-ARM-BAR-D

Finish: Dark bronze

USE: Round tube light bar installation, with Arm installation of lamps.



Aqm square tube turn tube tenon adaptor

NO. NUR-WSD-SADP-BAR-D

Finish: Dark bronze

USE: Round tube light bar installation, with Arm installation of lamps.

Fixture configurations:

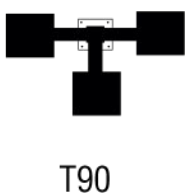
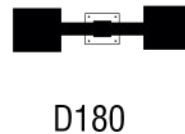

Light pole top:

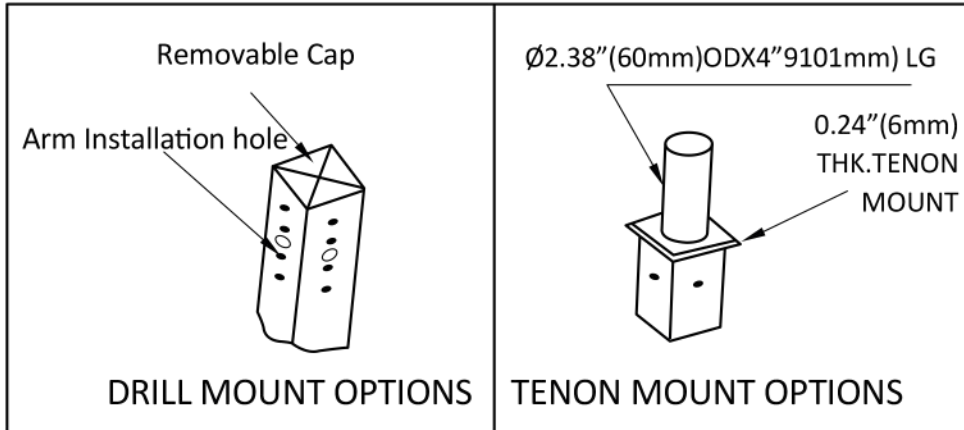

Installation:

