

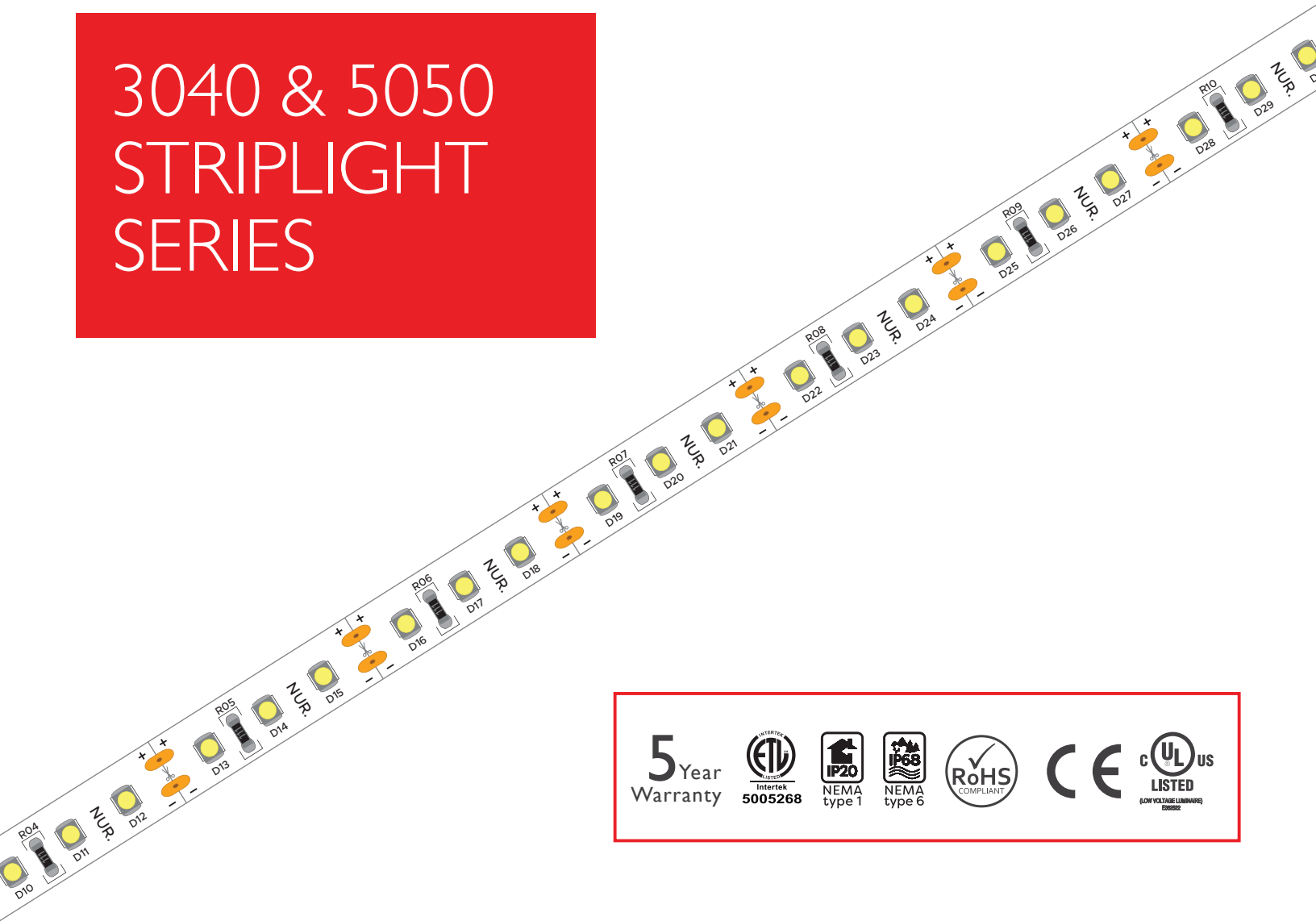

PRODUCT DATA SHEET

3040 & 5050
STRIPLIGHT
SERIES



5 Year Warranty

ETL Intertek 5005268

IP20 NEMA type 1

IP68 NEMA type 6

RoHS COMPLIANT

CE

UL US LISTED (LOW VOLTAGE LUMINAIRE) ENEC

Description

The NUR strip light series is an ingenious product that is used for accent or general lighting applications. The 5050 product has alternating RGB color changing LEDs and the 3040 uses a single color high brightness white LED. Each series of LEDs is soldered to a printed circuit board (PCB) which has either 6 or 3 LEDs in a series. Each series can be cut, soldered to, and connected to other strips. The NUR Strip Light Series operates on a low direct current (DC) voltage of either 12 or 24 and is generally installed with Class II wiring and transformers. This data sheet provides all variations of the product and what accessories are typically used with it.

Product Features

- LEDs have a High CRI > 90
- Specification Grade LED strips
- Fully dimmable
- Highest quality components and premium packaged 5050 & 3040 LEDs
- 12V or 24V DC Input.
- 120° Beam Angle
- Only 1/3"~1/2" (8~12mm) strip width
- Can be cut every 3 LEDs (6 LEDs for 24V)
- Operating Temperature -40°F to +183°F (-40°C to 83°C)
- Maximum Length in 5050 series 32ft (9.7 Meters) and 3040 series 100FT (30.4 Meters).
- IP68 is for OUTDOOR Use & IP20 Is for INDOOR Use.

Strip Light Colors

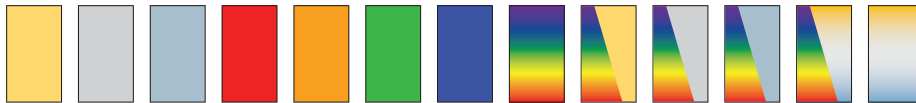

- Warm White 2200k~3500k
- Natural White 3450~4950k
- Cool White 5000k~10000K
- Red 620nm
- Amber 610nm
- Green 520nm
- Blue 455nm
- RGB-Red, Green, Blue(Color Changing)
- RGBWW- Red, Green, Blue+ 2700k(Color Changing+Warm White 2700k)
- RGBNW- Red, Green, Blue+4000k(Color Changing+Warm White 4000k)
- RGBCW- Red, Green, Blue+6000k(Color Changing+Warm White 6000k)
- RGBCB- Red, Green, Blue+2700-6000k(Color Changing+Color Balance)
- Color Balance 2700k-6000k

Product Specific Specifications

CRI>90	LD	SD	HD	2HD	4HD
WW Lumens per foot	128	231	462	580	685
NW Lumens per foot	135	244	488	613	725
CW Lumens per foot	144	260	520	652	770
Watts per foot	1.2W	2.2W	4.4W	5.5W	6.5W
Max Run per Connection (12V)	40ft	30ft	20ft	16ft	16ft
Max Run per Connection (24V)	100ft	60ft	40ft	32ft	25ft

Model	Density	Length	Color	IP rating	Voltage
STP-3040	LD	10FT or 15FT	2700°K or 3000°K or 3500°K or 4000°K or 4500° or 5000°K or 6000°K	IP20 or IP68	DC 12V or 24V
		10FT	AMBER or BLUE or GREEN or RED or PINK or UV		
	SD	10FT or 15FT	2700°K or 3000°K or 3500°K or 4000°K or 4500° or 5000°K or 6000°K		
		10FT	AMBER or BLUE or GREEN or RED or PINK or UV		
	HD	10FT or 15FT	2700°K or 3000°K or 3500°K or 4000°K or 4500° or 5000°K or 6000°K		
		10FT	AMBER or BLUE or GREEN or RED or PINK or UV		
	2HD	8FT	2700°K or 3000°K or 3500°K or 4000°K or 4500° or 5000°K or 6000°K AMBER or BLUE or GREEN or RED or PINK or UV		
	4HD	8FT	2700°K or 3000°K or 3500°K or 4000°K or 4500° or 5000°K or 6000°K AMBER or BLUE or GREEN or RED or PINK or UV		
STP-5050	SD	10FT	RGB		
	HD	10FT or 15FT or 32FT	RGB or CCT or RGB or RGBCB or RGBWW or RGBCW		
* STP - 3040 - HD 100FT length also available for 3000°K or 4000°K or 6000°K (IP20 24V only)					
SKU Builder: STP-3040_density_length_color_IP rating_voltage EX:STP-3040-2HD-8FT-3000K-IP20-12V					
*BOLD parts are normally stocked at LED CITY, but not bolded items can be special ordered.					

Ordering Code

Model	Density	Length	Color	IP Rating	Voltage
STP-3040	LD SD HD 2HD 4HD	08 FT - 08 ft Reel 10 FT - 10 ft Reel 15 FT - 15 ft Reel *32FT - 32 ft Reel	2700K or 3000K or 3500K or 4000K or 4500K or 5000K or 6000K or UV or PINK or AMBER or GREEN or RED or BLUE	IP20 IP68	DC12V or DC24V
STP-5050	SD HD	10 FT - 10 ft Reel 15 FT - 15 ft Reel *32FT - 32 ft Reel	RGB or CCT or RGBWW or RGBCW or RGBCB or RGBNW	IP20 IP68	DC12V or DC24V
SKU BUILDER:STP-3040_ <small>density</small> _length_color_IP rating_voltage EX:STP-3040-2HD-8FT-3000K-IP20-12V					
*32FT or 100FT lengths only available in 24V DC					

Dimensions

24V strip may be safely cut at cut marks occurring after every six diodes.

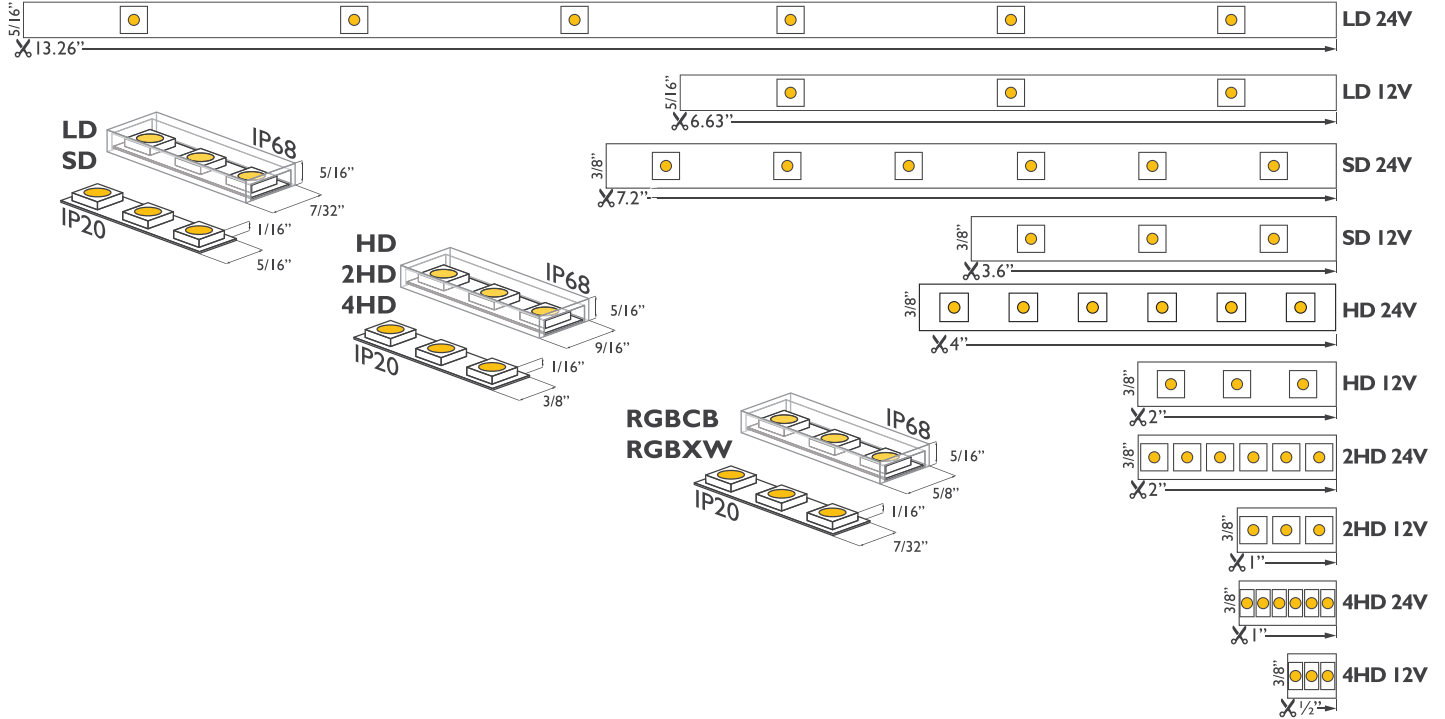

Strip Light cutting & wiring

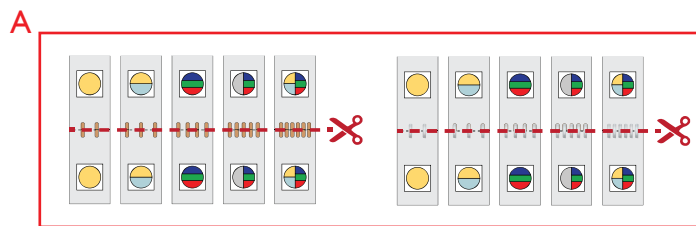

A: Strip can be cut directly on the copper contacts with the scissors logo.



B: Terminated ends can be soldered to with standard 50/50 rosin core lead solder.

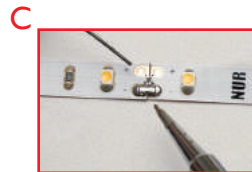

C: Two terminated ends can be soldered to one another.



D: Two terminated ends can be connected together (see Strip Light Connectors).

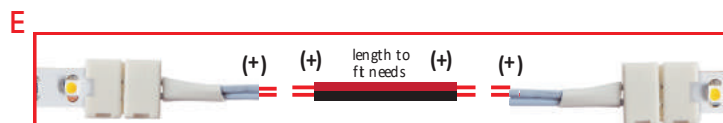

E: Connectors have two wires that can be cut and extended allowing installations with multiple runs connected together.

Example Installation and Layout

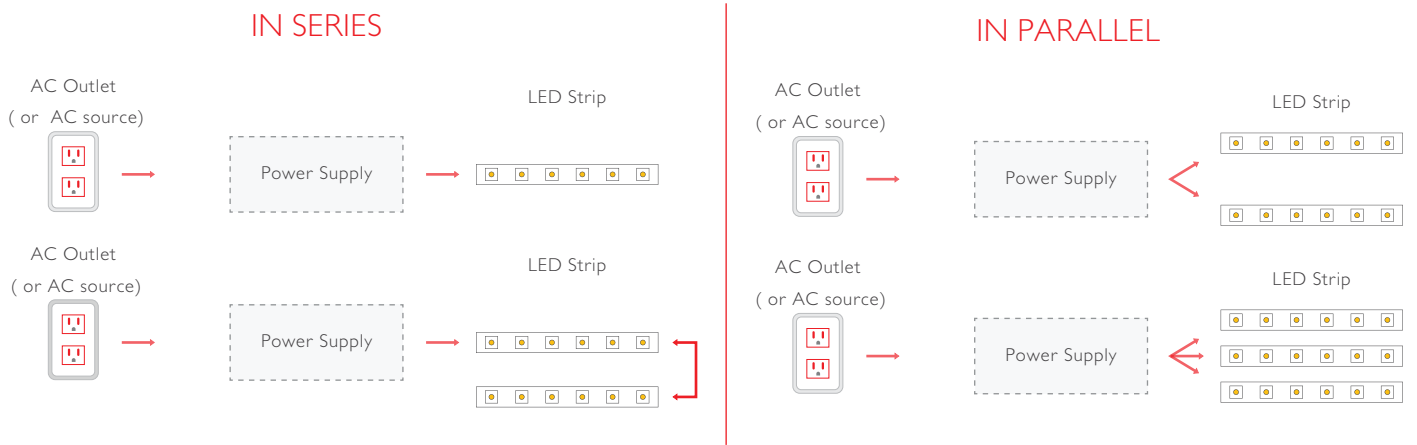

Dimming Options

In-Line Dimming

A = Toggle switching



B = Line voltage dimming



C = Low voltage dimming

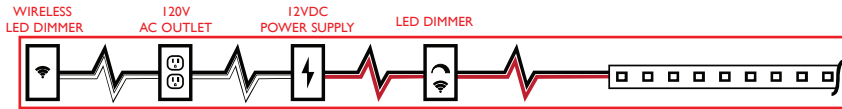

D = Automotive and marine



Strip Light Connectors (Couplers)

▶ Single Color Coupler



Can fit single color SD and HD striplights.
Available for indoor and outdoor locations
5 amp rating
SKU: CONN-CLP-8mm-CPL
SKU: CONN-CLP-8mm-CPL-OD
SKU: CONN-CLP-10mm-CPL
SKU: CONN-CLP-10mm-CPL-OD

▶ Color Balance Coupler Connector

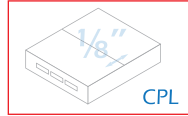

3pin coupler can be used with CCT striplights.
5 amp rating
SKU: CONN-CLP-10mm-CCT-CPL

▶ Color Changing (RGB) Coupler Connector

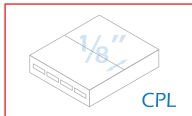

Can fit RGB color changing striplights.
Available for indoor and outdoor locations.
5 amp rating
SKU: CONN-CLP-RGB-CPL
SKU: CONN-CLP-RGB-CPL-OD

▶ RGBW Color Changing Coupler

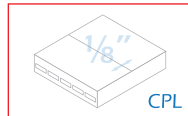

5pin coupler is suitable for RGBW striplights
5 amp rating
SKU: CONN-CLP-12mm-RGBW-CPL

▶ RGB Color Balance Coupler



RGB Color Balance Coupler
5 amp rating
SKU: CONN-CLP-12mm-RGBCB-CPL

Strip Light Connectors (Extenders)

▶ Single color Extender



Can be used with SD and HD striplights.
Available for indoor and outdoor locations
5 amp rating
SKU: CONN-CLP-8mm-EXT
SKU: CONN-CLP-8mm-EXT-OD
SKU: CONN-CLP-10mm-EXT
SKU: CONN-CLP-10mm-EXT-OD

▶ Color Balance Extender

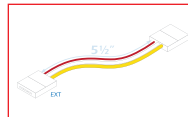

Can be used with CCT selectable striplights
5 amp rating
SKU: CONN-CLP-10mm-CCT-EXT

▶ RGB Color Changing Extender

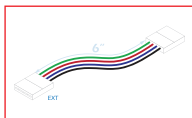

Can fit RGB color changing striplights.
Available for indoor and outdoor locations.
5 amp rating
SKU: CONN-CLP-RGB-EXT
SKU: CONN-CLP-RGB-EXT-OD

▶ RGBW Color Changing Extender

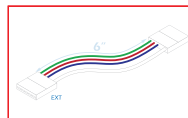

Can be used with RGBW striplights
5 amp rating
SKU: CONN-CLP-12mm-RGBW-EXT

▶ RGBCB Color Balance Extender



Can be used with RGB Color Balance striplights
5 amp rating
SKU: CONN-CLP-12mm-RGBCB-EXT

Strip Light Connectors (Wire Connector)

▶ T-Connector

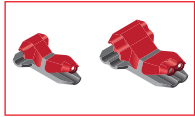

T-Connector
5 amp rating
1 Contact SKU: CONN-SW-LT1
2 Contact SKU: CONN-SW-LT2

▶ H-Connector

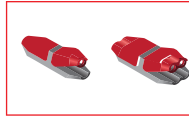

H-Connector
5 amp rating
1 Contact SKU: CONN-SW-LH1
2 Contact SKU: CONN-SW-LH2

▶ Snap Wire Connector



Snap Wire Connector
5 amp rating
SKU: CONN-WAGO-221-412/413

Strip Light Connectors (X, L, T Connectors)

▶ Cross Connector

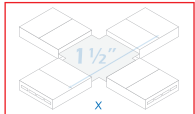

Provides solderless connection for striplights
Available for single color, CCT, RGB and RGBW
striplights. 5 amp rating.
SKU: CONN-CLP-8mm-CROSS
SKU: CONN-CLP-10mm-CROSS
SKU: CONN-CLP-CCT-CROSS
SKU: CONN-CLP-RGB-CROSS
SKU: CONN-CLP-RGBW-CROSS

▶ L CONNECTOR

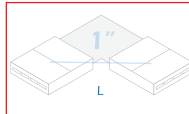

Provides solderless connection for striplights
Available for single color, CCT, RGB and RGBW
striplights. 5 amp rating.
SKU: CONN-CLP-8mm-L
SKU: CONN-CLP-10mm-L
SKU: CONN-CLP-CCT-L
SKU: CONN-CLP-RGB-L
SKU: CONN-CLP-RGBW-L

▶ T CONNECTOR

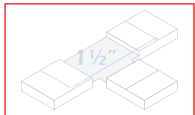

Provides solderless connection for striplights
Available for single color, CCT, RGB and RGBW
striplights. 5 amp rating.
SKU: CONN-CLP-8mm-T
SKU: CONN-CLP-10mm-T
SKU: CONN-CLP-CCT-T
SKU: CONN-CLP-RGB-T
SKU: CONN-CLP-RGBW-T

Solderless Connection Guide

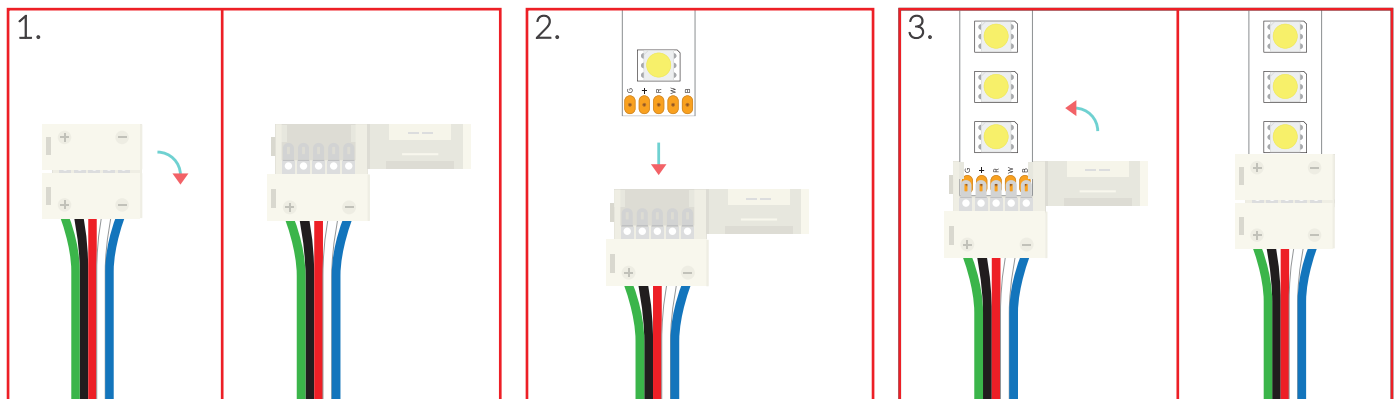

1. Open connector

2. Slide strip into connector with copper Pads under the connectors silver contacts

3. Close connector and test connection

Strip Light Connectors (Bare Connector)

▶ Single Color Bare Wire Connector

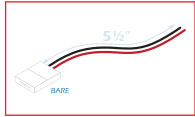

Can be used with single color striplights. 5 amp rating.
Available in 6inch and 3.3ft wire lengths.
Available for indoor and outdoor locations.
SKU: CONN-CLP-8mm-BARE, SKU: CONN-CLP-8mm-BARE-1M
SKU: CONN-CLP-8mm-BARE-OD, SKU: CONN-CLP-10mm-BARE-OD
SKU: CONN-CLP-10mm-BARE-1M, SKU: CONN-CLP-10mm-BARE

▶ RGBCB Bare Wire Connector

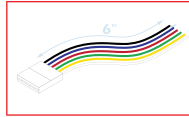

Can be used with RGB Color Balance striplights.
5 amp rating
Available in 6inch and 3.3ft wire lengths
CONN-CLP-12mm-RGBCB-BARE
CONN-CLP-12mm-RGBCB-BARE-1M

▶ RGB Color Changing Bare Wire Connector

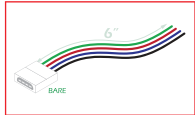

Can be used with RGB color changing striplights.
Available in 6inch and 3.3ft wire lengths. 5 amp rating.
Available for indoor and outdoor locations.
CONN-CLP-RGB-BARE
CONN-CLP-RGB-BARE-1M
CONN-CLP-RGB-BARE-OD

▶ RGBW Color Changing Bare Wire Connector

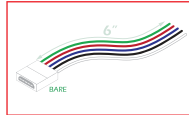

Can be used with RGBW striplights.
Available in 6inch and 3.3ft wire lengths
5 amp rating
CONN-CLP-12mm-RGBW-BARE
CONN-CLP-12mm-RGBW-BARE-1M

▶ CCT Bare Wire Connector

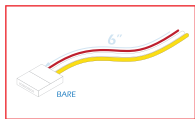

Can be used with CCT striplights.
Available in 6inch and 3.3ft wire lengths.
Available for indoor and outdoor locations.
5 amp rating
SKU: CONN-CLP-10mm-CCT-BARE

Strip Light Connectors (Bare Wire)

▶ 2 Pin Bare Wire



Wire Size: 18AWG, 20AWG
Wire Length: 25ft
Suitable for single color striplights
5 amp rating
SKU: CONN-2PIN-BARE-20AWG-ID

▶ 4 Pin Bare Wire (RGB) – 25ft



Wire Size: 18AWG, 20AWG
Wire Length: 25ft
Suitable for RGB color changing striplights
5 amp rating
SKU: CONN-4PIN-BARE-18AWG-ID
CONN-4PIN-BARE-20AWG-ID

▶ 20AWG 5 Pin Bare Wire (RGBW) – 25ft



Wire Size: 20AWG
Wire Length: 25ft
5 amp rating
Suitable for RGBW color changing striplights
SKU: CONN-5PIN-BARE-20AWG-ID

▶ 20AWG 6 Pin Bare Wire (RGBCB) – 25ft



Wire Size: 20AWG
Wire Length: 25ft
5 amp rating
Suitable for RGBW color changing striplights
SKU: CONN-6PIN-BARE-20AWG-ID

Strip Light Connectors (Quick Connectors)

▶ Single Pin Connector with Bare Wire – Female Connector



Bare wire female connector can connect directly to power adaptors.
5 amp rating
SKU: CONN-1PIN-FML-BARE(Lock)

▶ Single Pin Connector with Bare Wire – Male Connector



Bare wire female connector can connect directly to striplight controllers.
5 amp rating
SKU: CONN-1PIN-ML-BARE(Lock)

▶ Female Connector 1 Pin Terminal



Female terminal connector can connect directly to power adaptors.
5 amp rating
SKU: CONN-1PIN-TRMNL-FML

▶ Male Connector 1 Pin Terminal



Male terminal connectors can connect directly to striplight controllers.
5 amp rating
SKU: CONN-1PIN-TRMNL-ML

Power Adapters (24W, 60W, 100W)

► Power Adapter (24W, 60W, 100W)



Power Adapter Watt

24W
60W
100W

SKU

PWR-PLG-12V-24W-ID-G2
PWR-PLG-12V-60W-ID-G2
PWR-PLG-12V-100W-ID-G2

Power Supply (Dimmable)

► Outdoor Power Supply 0-10V dimming- 12V or 24V Output



DC Output Voltage

12V
12V
12V
12V
24V
24V

Power Supply Watt

30W
60W
100W
200W
100W
200W

SKU

PWR-010V-30W-12V-OD
PWR-010V-60W-12V-OD
PWR-010V-100W-12V-OD
PWR-010V-200W-12V-OD
PWR-010V-100W-24V-OD
PWR-010V-200W-24V-OD

► Outdoor Phase/Triac Dimmable Power Supply – 12V or 24V DC Output



DC Output Voltage

12V or 24V
12V or 24V
12V or 24V

Power Supply Watt

80W
100W
200W

SKU

PWR-DIM-NUR-12Vor24V-80W-OD
PWR-DIM-NUR-12Vor24V-100W-OD
PWR-DIM-NUR-12Vor24V-200W-OD

► Indoor Phase Dimming Power Supply – 12V or 24V DC Output



DC Output Voltage

12V
12V or 24V
12V or 24V

Power Supply Watt

5W
25W
50W

SKU

PWR-DIM-NUR-12V-5W-ID
PWR-DIM-NUR-12Vor24V-25W-ID
PWR-DIM-NUR-12Vor24V-50W-ID

▶ Junction Box (25W, 50W, 100W, 200W)





				Junction Box Watt	SKU
				25W 50W 100W 200W	PWR-JB-25 PWR-JB-50 PWR-JB-100 PWR-JB-200

▶ MAGNITUDE Dimmable Driver (20-300W) – 12VDC Output

	DC Output Voltage	Power Supply Watt	SKU
	12V or 24V	20W	PWR-DIM-DRV-12Vor24V-20W
	12V or 24V	60W	PWR-DIM-DRV-12Vor24V-60W
	12V or 24V	100W	PWR-DIM-DRV-12Vor24V-100W
	12V or 24V	200W	PWR-DIM-DRV-12Vor24V-200W
	12V or 24V	300W	PWR-DIM-DRV-12Vor24V-300W

Power Supply (Non-Dimmable)

▶ Meanwell Power Supply-Outdoor Rated 12VDC or 24VDC

Product Picture	DC Output Voltage	Power Supply Watt	SKU
	12V	35W	PWR-DRV-12V-35W-OD-MW
	12V	60W	PWR-DRV-12V-60W-OD-MW
	12V	100W	PWR-DRV-12V-100W-OD-MW
	24V	100W	PWR-DRV-24V-100W-OD-MW

Compatible Aluminum Extrusions

▶ Aluminium Extrusions Suspended O-1818

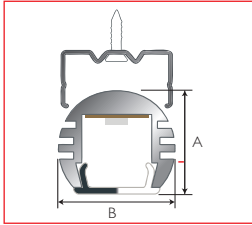

A: 1 1/16" or 0.68" ~ 16.6mm
 B: 7/32" or 0.47" ~ 11.2mm
 SKU: AE-1818-Suspended O-1M
 SKU: AE-1818-Suspended O-2M

▶ Aluminum Extrusion Recessed – Mini Step 082

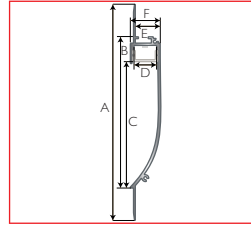

A: 5 1/4" or 5.27" ~ 133.8mm
 B: 3 1/16" or 3.69" ~ 93.8mm
 C: 33/32" or 3.08" ~ 78.3mm
 D: 9/16" or 0.55" ~ 13.9mm
 E: 5/8" or 0.61" ~ 15.5mm
 F: 3/4" or 750" ~ 18.05
 SKU: AE-ALP082-Recessed-Mini-Step-2M

▶ Aluminum Extrusion Recessed Mount – 087

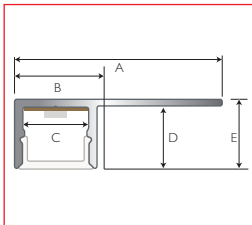

A: 15/13" or 1.30" ~ 33.1mm
 B: 1/2" or 0.52" ~ 13.1mm
 C: 7/16" or 0.41" ~ 10.5mm
 D: 3/8" or 0.39" ~ 10mm
 E: 7/16" or 0.43" ~ 11mm
 SKU: AE-087-AP-REC-2M

▶ Aluminum Extrusions Quarter Round-1616

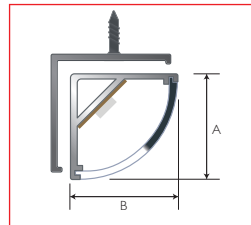

A: 5/8" or 0.62" ~ 16mm
 B: 5/8" or 0.62" ~ 16mm
 SKU: AE-BK-1616-QRound-2M
 SKU: AE-1616-Quarter Round-2M
 SKU: AE-1616-Quarter Round-1M

▶ Aluminum Extrusions Deep Flange-A035

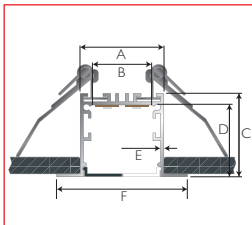

A: 1 3/8" or 1.375" ~ 35mm
 B: 1" or 1.00" ~ 25mm
 C: 1 1/4" or 1.25" ~ 31.75mm
 D: 1 3/8" or 1.375" ~ 35mm
 E: 1/16" or .06" ~ 1.2mm
 F: 0.63" ~ 55mm
 SKU: AE-A035-Deep Flange-2M

▶ Round Surface Baseboard-18mm

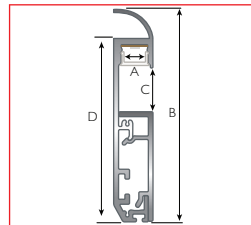

A: 7/16" or 0.43" ~ 10.5mm
 B: 35/16" or 3.3" ~ 84mm
 C: 1 1/16" or .6875" ~ 17.46
 D: 23/4" or 2.72" ~ 69mm
 SKU: AE-SK1580-18-Surface Baseboard-2M

▶ Aluminum Extrusions Recessed Mount –086

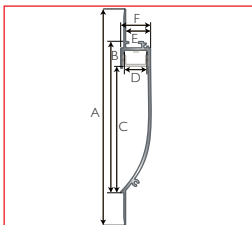

A: 5 1/4" or 5.27" ~ 133.8mm
 B: 3 1/16" or 3.69" ~ 93.8mm
 C: 33/32" or 3.08" ~ 78.3mm
 D: 9/16" or 0.55" ~ 13.9mm
 E: 5/8" or 0.61" ~ 15.5mm
 F: 3/4" or 750" ~ 18.05
 SKU: AE-ALP086-Recessed-Step-2M

▶ Recessed Baseboard-18mm

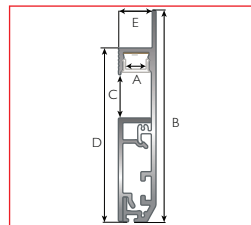

A: 7/16" or 0.43" ~ 10.5mm
 B: 35/16" or 3.3" ~ 84mm
 C: 1 1/16" or .6875" ~ 17.46
 D: 23/4" or 2.72" ~ 69mm
 E: 9/16" or .5625" ~ 14.8mm
 SKU: AE-SK1580TR-18-Recessed Baseboard-2M

▶ Aluminum Extrusions Universal Slim-1506

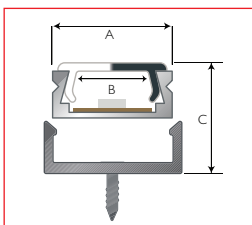

A: 5/8" or 0.62" ~ 15.21mm
 B: 3/16" or 0.1875" ~ 5.22mm
 C: 1/4" or 0.250" ~ 7.04mm
 SKU: AE-AE-BK-1506-Uni Slim-1M
 SKU: AE-1506-Uni Slim-1M
 SKU: AE-1506-Uni Slim-2M

▶ Aluminum Extrusions Double Wide Slim-2310

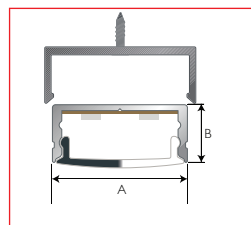

A: 15/16" or .93" ~ 23.62mm
 B: 3/8" or .37" ~ 10.4mm
 SKU: AE-2310-Double Wide Slim-2M

▶ Aluminum Extrusions Recessed – Universal Wide 071

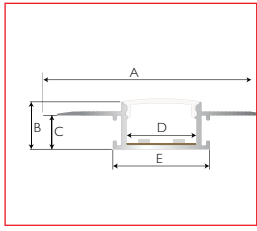

A: 2 1/2" or 2.50"~61.50mm
 B: 9/16" or .56"~14.29mm
 C: 3/8" or .37"~9.53mm
 D: 13/16" or 0.81"~20.64mm
 E: 1 1/8" 1.13 28.70
 SKU:AE-ALP071-Recessed-Uni-Wide-2M

▶ Aluminum Extrusions Flat-1201

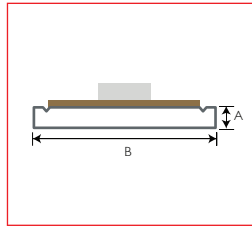

A: 5/8" or 0.62"~15.88mm
 B: 5/8" or 0.62"~15.88mm
 SKU:AE-1201-Flat-1M

▶ Aluminum Extrusions Hanger-R003

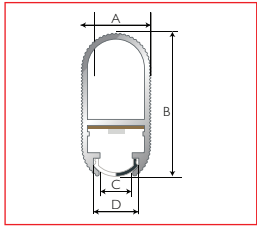

A: 9/16" or 0.56"~14.29mm
 B: 1 1/4" or 1.25"~31.75mm
 C: 5/16" or .31"~7.94mm
 D: 3/8" or 0.37"~9.53"
 SKU:AE-R003-Hanger-1M

▶ Aluminum Extrusions Recessed- Mud in Crown 128

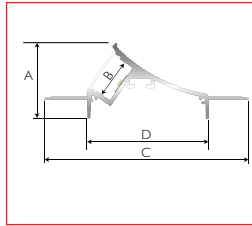

A: 1 3/8" or 1.37"~34.93mm
 B: 3/4" or .75" 19.05mm
 C: 33/4" or 3.7"~95.7mm
 D: 2 3/8" or 22.3"~56.8mm
 SKU:AE-ALP128- Mud-In-Crown-2M

▶ Aluminum Extrusions Wide-Flange-055

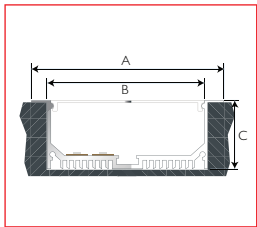

A: 3 1/2" or 3.50"~88.90mm
 B: 27/8" or 2.95"~74.93mm
 C: 1 1/4" or 1.25"~31.75mm
 SKU:AE-055-Wide Flange-2M

▶ Aluminum Extrusions Recessed – Inside Corner 069

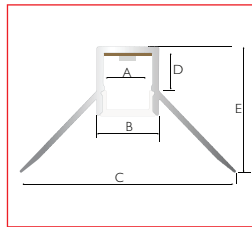

A: 3/8" or .37"~9.53mm
 B: 1/2" or .50"~12.70mm
 C: 1 3/4" or 1.75"~ 44.45mm
 D: 5/16" or 0.31"~7.94mm
 E: 1 1/16" or 1.00"~26.99mm
 SKU:AE-ALP069-Recessed-Inside-Corner-2M

▶ Aluminum Extrusions Universal Wide-1715

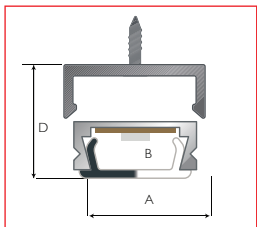

A: 1 1/16" or .68"~17.46mm
 B: 1/2" or .50"~12.70mm
 C: 5/8" or .62"~15.88mm
 SKU:AE-BK-1715-Uni Wide-2M
 SKU:AE-1715-Uni Wide-1M

▶ Aluminum Extrusions Universal-1612

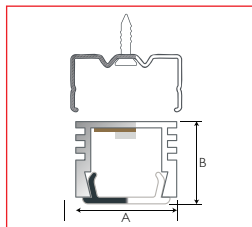

A: 5/8" or .625"~15.88mm
 B: 1/2" or .500"~12.70mm
 SKU:AE-1612-Uni-2M
 SKU:AE-1612-Uni-1M

▶ Aluminum Extrusions Up Down-040L

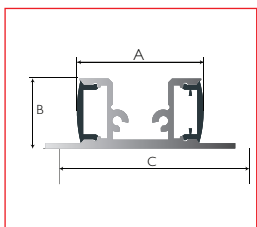

A: 1 1/4" or 1.25"~ 31.75mm
 B: 1 1/16" or .68"~17.46mm
 C: 1 29/32" or 1.90"~48.6mm
 SKU:AE-040L-Up Down-2M

▶ Aluminum Extrusions Recessed – Outside Corner 070

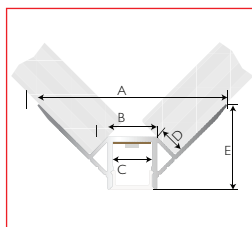

A: 2" or 2.0"~50.80mm
 B: 1/2" or .50"~12.70mm
 C: 3/8" or .37"~ 9.53mm
 D: 1/4" or .25"~ 6.35mm
 E: 7/8" or 0.87"~ 22.23mm
 SKU:
 AE-ALP070-Recessed-Outside-Corner-2M

▶ Aluminum Extrusions Recessed-Wide Smooth I10

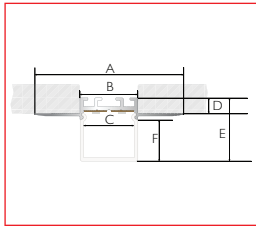

A: 2 1/2" or 2.50"~ 63.50mm
 B: 1" or 1.00"~ 25.40mm
 C: 7/8" or .875"~ 22.23mm
 D: 5/16" or .31"~ 7.94mm
 E: 1 1/8" or 1.13"~ 28.70mm
 F: 3/4" or .75"~ 19.05mm
 SKU:
 AE-ALP I10-S-Recessed-Wide-Smooth-2M

▶ Aluminum Extrusions Shelf-044a

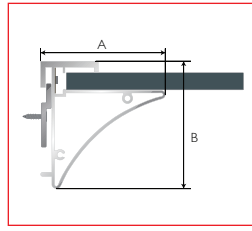

A: 2 1/4" or 2.25"~57.15mm
 B: 2 1/4" or 2.25"~57.15mm
 SKU:AE-044A-Shelf-2M

▶ Aluminum Extrusions Smooth Round-2623

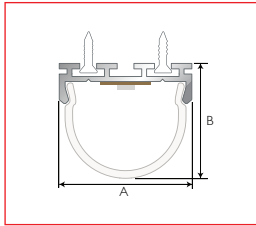

A: 1 1/8" or 1.13"~28.70mm
 B: 7/8" or .875"~22.23
 SKU:AE-2623-Smooth Round-2M

▶ Aluminum Extrusions Smooth Square-2114

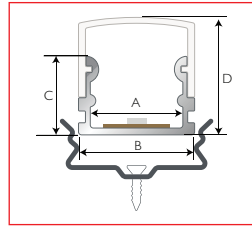

A: 5/8" or .625"~15.88mm
 B: 13/16" or .81"~ 20.64mm
 C: 9/16" or .56"~14.29mm
 D: 13/16" or .81"~20.64mm
 SKU:AE-2114-Smooth Square-2M

▶ Aluminum Extrusions Smooth Track-011

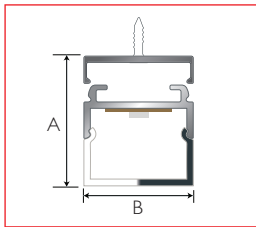

A: 3/4" or .75"~19.05mm
 B: 3/4" or .75"~19.05mm
 SKU:AE-011-Smooth Track-2M

▶ Aluminum Extrusions Double Cove-090

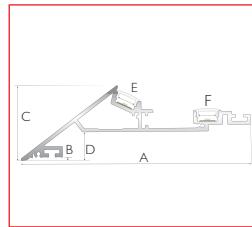

A: 5 3/4" or 5.7"~146mm
 B: 1/8" or .125"~3.18mm
 C: 1 3/4" or 1.75"~46mm
 D: 3/4" or .75"~ 19.05mm
 E: 1/2" or .50"~12.70mm
 F: 1/2" or .50"~12.70mm
 SKU:AE-ALP090-Double-Cove-2M

▶ Aluminum Extrusions Surface-Square 068

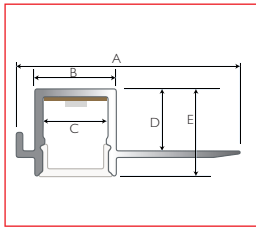

A: 1 3/8" or 1.37"~34.93mm
 B: 1/2" or .500"~12.70mm
 C: 3/8" or .375"~9.53mm
 D: 3/8" or .375"~ 9.53mm
 E: 9/16" or .56"~ 14.29mm
 SKU:AE-ALP068-Recessed-Universal-2M

▶ Aluminum Extrusions Universal Recessed-2212

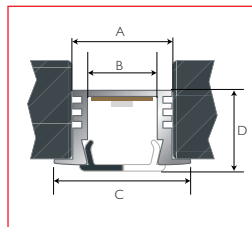

A: 5/8" or .62"~15.88mm
 B: 7/16" or .43"~11.11mm
 C: 7/8" or .87"~ 22.23mm
 D: 1/2" or .50"~12.70mm
 SKU:AE-2212-Uni-Rec-1M

▶ Aluminum Extrusions Universal Slim Recessed-2206

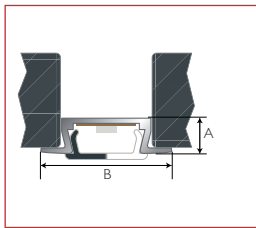

A: 5/16" or 0.31"~7.94mm
 B: 7/8" or 0.87"~22.23mm
 SKU:AE-2206-Uni Slim-Rec-1M

▶ Aluminum Extrusions Universal Wide Slim-1706

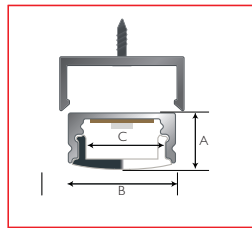

A: 1/4" or 0.25"~6.35mm
 B: 1 1/16" or 0.68"~17mm
 C: 7/16" or 0.43"~11.11mm
 SKU:AE-1706-Uni Wide Slim-1M)

Remotes

▶ Milight Remote Holder



* Holder for MiLight remote control.
SKU: MILI-REM HOLDER

▶ Milight Color Balance Remote



* 4 zone warm white to cool white color changing remote.
SKU: MILI-REM-CB

▶ Milight RGB Remote



* 4 zone RF RGBW color changing remote.
SKU: MILI-REM-RGBW

▶ Milight RGBWW Remote



*4 zone RF RGBW color changing remote.
SKU: MILI-REM-RGBWW

▶ 8 Zone RGB+CCT Remote Controller



* Working Temperature: -4°F to 140°F (-20°C to 60°C)
* Voltage: 3V(2*AAA Battery)
* Transmission Frequency: 2400-2483.5MHz
* Modulation Method: GFSK
* Transmitting Power: 6dBm
* Control Distance: 30m
* Standby Power: 15uA
SKU: MILI-REM-RGBWW-8Z

Panel Remote Controllers

▶ 4-Zone Brightness Dimming Smart Panel Remote Controller



* Working Temperature: -4°F to 140°F (-20°C to 60°C)
* Voltage: 3V(2*AAA Battery)
* Transmission Frequency: 2400-2483.5MHz
* Modulation Method: GFSK
* Transmitting Power: 6dBm
* Control Distance: 30m
* Standby Power: 15uA
SKU: MILI-REM-DIM-4Z (Panel)

▶ 4 Zone RGB+CCT Smart Panel

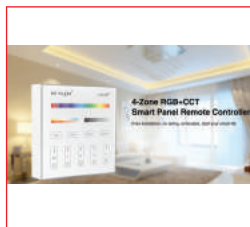

SKU: MILI-REM-RGBWW-WALL-4Z

▶ 8 Zone Smart Panel Remote Controller



*Working Temperature: -4°F to 140°F (-20°C to 60°C)
*Voltage: 3V(2*AAA Battery) / DC3.3V
*Transmission Frequency: 2400-2483.5MHz
*Transmitting Power: 6dBm
*Control Distance: 30m
*Panel Size: 4.17in. x 5.75in. x 0.79in. (106mm x 146mm x 20mm)
SKU: MILI-REM-RGBWW-WALL-8Z

MiBoxer (r) Controller & Amplifier

▶ 4 Channel High Speed Amplifier



- * Power twice as many LEDs in your project with the amplifier
- * Compatible with all PWM series LED controllers in market
- * Input Voltage: 12V/24V DC
- SKU: MILI-CONT-AMP

▶ 5 IN 1 Smart LED Controller



- * 2.4GHz remote and smartphone control
- * Compatible with single color, CCT, RGB, RGBW and RGB+CCT output mode
- * Input Voltage: 12-24V DC
- * SKU: MILI-CONT-RGBCB-STP

▶ WiFi Controller Bridge – 2.4GHz Gateway



- * Adjust ON/OFF, brightness, color temperature and change light
- * colors through voice command.
- SKU: MILI-WIFI-BRIDGE-G2

▶ Single Color LED Strip Light Controller



- * 2.4GHz remote control and App control
- * Compatible with single color output modes
- * Input Voltage: 12-24V DC
- SKU: MILI-CONT-G2-DIM-STP

▶ Dual White (CCT) LED Strip Controller



- * 2.4GHz remote control and App control
- * Color temperature adjustable from warm white to cool white, dimmable control
- SKU: MILI-CONT-G2-CCT-STP

▶ RGB LED Strip Controller



- * 2.4GHz remote control and App control
- Mix Red, Green and Blue light to adjust color temperature.
- SKU: MILI-CONT-G2-RGB-STP

▶ RGBW LED Strip Controller



- * 2.4GHz remote control and App control
- * 16 million colors to choose from
- * Input Voltage: 12-24V DC
- SKU: MILI-CONT-G2-RGBW-STP

Sun Richer (R) Controller

▶ 5A 4-Channel 12-36V Constant Voltage RF LED Strip Dimmer Controller



- * Constant voltage LED strip dimmer controller
- * Input Voltage: 12-36V DC
- * Suitable for single color, dual color and RGB/RGBW lights.
- SKU: CONT-SR-1009FA

▶ RF and WiFi RGBW Wall Mounted Touch Panel LED Controller



- *User-friendly interface, easy and simple operation
- *Operation return function
- *Control 1 zone, each zone can be set endless receivers, each receiver maximally be controlled by 8 different remotes
- *Preset 10 changing modes, with pause function
- SKU: CONT-SR-2820S-US

▶ RF and Wi-Fi rotary LED Dimmer



- * Rotary dimmer controller which offers both switch and smooth brightness dimming functions for single color LED lighting.
- SKU: CONT-SR-2836DIM-US

▶ RF and WiFi RGB Controlle



- * LED rotary dimmer switch which offers switch, brightness dimming and color tone adjustment functions
- SKU: CONT-SR-2836-RGB-US

Safety And Disclosures

Installation must be in accordance with NFPA 70®, National Electrical Code® (NEC®)

To ensure safety and correct installation, our strips are intended to be installed by a qualified, licensed electrician.

Only install with a Class 2 DC Constant Voltage LED driver to meet UL requirements.

Do not install in environment where excessive heat may exist.

LED strip lights must be handled with care. Excessive handling, bending, and pressure may damage the product, voiding the warranty.

Do not install indoor LED tape light products in outdoor / wet location environments. Only use copper wiring. Use wires rated for at least 176°F (80°C) and certified for use with external connection of electrical equipment.

Each maximum run requires a dedicated power feed from the driver. Do not extend beyond the recommended maximum run length.

Make sure the appropriate gauge wire is installed between driver, LEDs, and any dimmers. When choosing wire, calculate voltage drop, maximum amperage rating, and the location ratings on the wire. Improper wire selection and installation could overheat wires, and cause fire.

Do not modify the product beyond the instructions or the warranty will be void.

We reserve the right to modify and improve the design of our fixtures without prior notice. Although we try our best to order the same colors every time, due to changes in technology and phosphors over time, we cannot guarantee to match existing installed fixtures for subsequent orders or replacements in regards to product appearance, CCT, or lumen output.

Warranty Information

Lighting Product Warranty

In the event that any product is found to have a manufacturer's defect within the warranty period, LED City® will, at their discretion, repair or replace the defective product/part, or refund the amount paid for the product. The warranty period is based upon the product and becomes effective from the date of shipment or invoice. The warranty does not cover aesthetic degradation of the product.

This warranty is void if:

1. The product was operated or stored in abnormal use or maintenance conditions.
2. The product is repaired, modified or altered in any way.
3. The product is damaged by abuse, accident, or acts of nature.
4. The product was installed improperly or incorrect voltage was applied.
5. The product casing has been opened.

The LED industry is a vast and quickly growing industry and the products are continually evolving. Aesthetic appearance of goods may change from order to order. LED City® cannot guaranty the product will look exactly the same on different orders. If a defective product is repaired or replaced, company cannot guaranty that the brightness or color temperature will match exactly the same as the other products ordered. Since the LED is newer and comes from a different manufacturing batch, color temperature and brightness may not be exactly the same. Furthermore, LED's brightness can vary depending upon levels of usage, temperature operated in, and conditions of the fixture.

Product repair, replacement or refund is LED City's® sole warranty obligation, and incidental and consequential damages are excluded. No one is authorized to make any other warranties on behalf of LED City®, or modify this warranty, except in a separate written paper document under signature of a corporate officer of LED City® then-listed with the Texas Secretary of State.

Company will not be liable for repairing damages or failures caused by acts of God, abuse, mishandling, alteration, accident, electrical current fluctuations, failure to follow operating, maintenance or environmental instructions prescribed by Company, abnormal usage, or any other use or application for which the Products are not intended. LED City® will not be liable for incidental or consequential damages connected with or in lieu of using its goods or services in respects to loss of property, damages, revenues, life or limb, personal injury, claimant's remedies will be limited only to repair or replacement of the goods equal to the cost of the non-conforming goods.